

The logo consists of a red square containing a white stylized 'E' symbol, followed by the word 'PLASSON' in white uppercase letters on a red rectangular background.

PLASSON

ELECTROFUSION FITTINGS

A close-up photograph of a metal fitting with a textured surface. The word 'PLASSON' is embossed in large, bold, uppercase letters across the middle of the fitting. Below it, the letters 'IC' and the number '0110' are also embossed.

PLASSON

IC 0110

Introduction Introducción

ElectroFusion System	90	Sistema ElectroFusión	91
Table of Contents	92 - 97	Indice	92 - 97
Fittings	98 - 137	Accesorios	98 - 137
Wastewater Line	138 - 142	Aguas residuales	138 - 142
Technical Specifications	144	Especificaciones técnicas	145
Controllers	146 - 149	Soldadoras automáticas	150 - 159
Installation Tools	160 - 168	Herramientas de instalación	160 - 168
Minimum required Generator Output power	169	Potencia mínima requerida de un generador de energía eléctrica, Potencia de salida	169
Extension power cable size	170	Cable alargador de alimentación	170

PLASSON, a worldwide leader in fittings for polyethylene pipes for over 40 years, now offers a complete line of ElectroFusion products including: Plasson ElectroFusion fittings, tools and control boxes.

Plasson ElectroFusion products combine to offer a reliable smart-system solution featuring fully computerized control and monitoring.

PLASSON's customers benefit from the Company's quality products, expertise and worldwide first-rate service in water, gas distribution, Waste-Water Systems, Geothermal applications and industrial applications.

PLASSON, líder mundial en accesorios para tuberías de polietileno desde hace más de 40 años, presenta ahora una línea completa de productos de electrofusión, entre ellos: conectores, herramientas y soldadoras automáticas de ElectroFusión. La combinación de productos ElectroFusion de Plasson ofrece una solución inteligente y confiable que integra el control y la monitorización completamente computarizados.

Los clientes de PLASSON se benefician de los productos de calidad, la pericia y el excelente servicio mundial de la compañía en instalaciones de distribución de agua y gas, y aplicaciones industriales.

Subsidiary Companies Subsidiarias

Australia

Plasson Australia (PTY) Ltd.
E-mail: info@plasson.com.au
www.plasson.com.au

Brasil

Plasson Do Brasil
E-mail: plasson@plasson.com.br
www.plasson.com.br

France

Plasson France S.A.
E-mail: commercial@plassonfrance.fr
www.plasson.fr

Germany

Plasson GmbH
E-mail: info@plasson.de
www.plasson.de

Italy

Plasson Italia
E-mail: info@plasson.it
www.plasson.it

Poland

Plasson Polska Sp.z o.o.
E-mail: bs@plasson.pl
www.plasson.pl

South Africa

PLASSON SA Pty Ltd, t/a PPA
E-mail: support@ppa.co.za
www.ppa.co.za

Spain

Plasson Spain S.L.
E-mail: plasson@plasson.es
www.plasson.es

United Kingdom

Plasson UK Ltd.
E-mail: miron@plasson.co.uk
www.plasson.co.uk

USA

Plasson USA
E-mail: sales@plassonusa.com
www.plassonusa.com

Plasson ElectroFusion System

The Smart-System Solution You Can Depend On

Plasson ElectroFusion Fittings

Plasson fittings are specifically designed for reliable, high performance pipe joining and long system life. This automated system has been proven to be most economical due to the low potential for operator error.

Tools and Control Box

Plasson offers quality tools and control boxes allowing for easy installation. Plasson control boxes provide computerized ElectroFusion with minimal potential for operator error. The Plasson control boxes are the economical solution for reliable ElectroFusion.

The Smart Fuse System - Plasson ElectroFusion

All Plasson products combine to form the latest state-of-the-art high performance pipe joining solution. Plasson ElectroFusion fittings are part of a complete ElectroFusion Smart Fuse System. The entire ElectroFusion process is executed and fully monitored by the computerized control box. Everything is computer-controlled ensuring safe, dependable connections.

Plasson ElectroFusion fittings can be used with Plasson's computerized Smart Fuse System control box or with standard barcode systems. Each Plasson ElectroFusion fitting comes complete with a barcode.

Advantages

Stronger pipe joining - Plasson ElectroFusion quality fittings have long penetration depths and fusion zones which ensure high quality joints.

Most Economical - Economic benefits are a result of overall integrated system quality and innovation including the computerized Smart Fuse System which reduces the potential for operator error.

Plasson ElectroFusion Smart Fuse System Features

- **Superior Fitting Design**
increases joint integrity
- **Automatic Controller**
decreases potential operator error
- **Computerized Data Retrieval**
ensures quality control by Joint Data retrieval of measurements and records
- **Compatibility**
between Plasson ElectroFusion and other ElectroFusion systems through the computerized barcode system
- **Easy Installation**
using PLASSON's simple, practical tools
- **High Standards**
are ensured by the latest product testing methods

High Performance - Proven high performance in gas and water distribution and industrial applications.

Superior Service - Plasson provides unmatched service based on over 40 years in the field.

Sistema ElectroFusion de Plasson

La solución inteligente de confianza

Accesorios ElectroFusion de Plasson

Los accesorios ("fittings") de Plasson para tuberías han sido especialmente diseñados para asegurar conexiones fiables, de alto rendimiento y prolongada vida útil. Se ha comprobado que este sistema automatizado es el más económico, gracias a la escasa probabilidad de errores por parte del operador.

Herramientas y soldadora automática de ElectroFusión

Plasson ofrece herramientas de alta calidad y soldadoras automáticas que se instalan fácilmente. Las soldadoras, que proporcionan un proceso computarizado con mínima probabilidad de error humano, son la solución más económica para una electrofusión de máxima confianza.

ElectroFusion de Plasson - El sistema inteligente

Los productos de Plasson se combinan para ofrecer la solución más avanzada y rendidora en la conexión de tuberías. Los accesorios ElectroFusion de Plasson forman parte de un sistema completo e inteligente. La soldadora automática de ElectroFusión está a cargo de la ejecución y la monitorización del proceso. El sistema controlado por computadora asegura conexiones seguras y confiables.

Ventajas

Uniones más resistentes - Los accesorios de alta calidad ElectroFusion de Plasson tienen grandes profundidades de penetración y zonas de fusión que aseguran juntas muy resistentes.

La solución más económica - El beneficio económico es el resultado de la calidad y la innovación del sistema computarizado totalmente integrado, que reduce la probabilidad de error humano.

Características del sistema inteligente ElectroFusion de Plasson

- **Excelente diseño**
asegura la integridad de la conexión
- **Control automático**
reduce la probabilidad de error humano
- **Recuperación de datos**
calidad asegurada mediante la recuperación de datos de mediciones y registros
- **Compatibilidad**
con el sistema ElectroFusion de Plasson y otros sistemas de códigos de barras
- **Instalación sencilla**
mediante las herramientas prácticas y simples de PLASSON
- **Estándar elevado**
asegurado por los métodos de prueba de productos de última generación

Alta performance - Elevado rendimiento comprobado en instalaciones de distribución de gas y agua, y aplicaciones industriales.

Excelente servicio - Plasson le brinda un servicio inigualado, con su pericia y experiencia de más de 40 años en el terreno.

Fittings

490104/490103

Page 98 | Coupler
Enlace Recto



4901L4

Page 99 | Long Coupler
Enlace Largo



450104

Page 99 | Coupler (PN 25)
Enlace Recto (PN 25)



460104/460103

Page 100 | LightFit Coupler (PN 10)
Enlace LightFit (PN 10)



4601S3

Page 101 | Super LightFit (PN 6.4)



491104

Page 101 | Reducing Coupler
Enlace Reductor



491107

Page 102 | Spigot Reducer
Reductor Espiga



49009

Page 103 | Flex Restraint



494204

Page 103 | Monolithic End Cap
Tapón Monolítico



491204

Page 104 | End Cap
Tapón



491207

Page 105 | Spigot End Plug
Tapón Espiga



490404

Page 106 | Tee 90°
Enlace T 90°



492404

Page 106 | Two Outlets Reducing Tee
Enlace te Reductor con Salida Doble



491404

Page 107 | Reducing Tee
Enlace Reductor



499404

Page 108 | Flanged Tee
Enlace T Bridado



490504

Page 108 | Elbow 90°
Codo 90°



490604

Page 109 | Elbow 45°
Codo 45°



490804

Page 109 | Elbow 22.5°
Codo 22.5°



46060

Page 110

LightFit Elbow 45°
Codo LightFit 45°



46330

Page 110

LightFit Elbow 30°
Codo LightFit 30°



46370

Page 110

LightFit Elbow 15°
Codo LightFit 15°



490904

Page 111

Elbow 180°
Codo 180°



491904

Page 111

Y Reducer
Y Reductor



491504

Page 112

Duckfoot Elbow 90°
Codo 90° Empotrable



4915Q4

Page 112

Duckfoot Elbow 90° with Outlet
Codo 90° Empotrable con
Toma de Servicio



4947C4

Page 113

Adjustable Elbow
Codo Ajustable



4947D4

Page 113

Adjustable Elbow One Sided
Codo Ajustable Enlace/
Espiga



496804

Page 114

Balloon Saddle
Collarín Globo



498304

Page 114

Monolithic Weld End Cap for
Ballon Saddle
Tapón Monolítico Soldable
para Collarín Globo



4958T

Page 115

Saddle BSPP Female Outlet
Collarín BSPP Rosca
Hembra



495204

Page 115

Repair Saddle
Toma de Reparación



493804

Page 116

Transition Saddle
Collarín de Transición



495804

Page 117

Branch Saddle
Collarín de Derivación



495804

Page 118

Branch Saddle
Collarín de Derivación



495803

Page 118

XL&XXL Branch Saddle
XL&XXL Collarín de
Derivación



4758W

Page 119

LightFit Branch Saddle
Collarín de Derivación
LightFit



495904

Page 120 | Flange Branch Saddle
Collarín bridado



495204

Page 120 | Repair Saddle
Collarín de reparación



496304

Page 121-122 | Tapping Saddle
Toma de Servicio



4963P4

Page 123 | Tapping Saddle Parallel Outlet
Toma de Servicio Salida Parallel Outlet



498304

Page 124 | Welding Cap for Tapping Saddle
Tapón Soldable para toma de Servicio



436207

Page 124 | PE Ball Valve
Válvula de Bola PE



495404/4954S4

Page 125-126 | Tapping Valve
Toma de Servicio con Válvula



492104

Page 127 | Male Transition Coupler
Enlace de Transición Macho



493104

Page 127 | Female Transition Coupler
Enlace de Transición Hembra



492504

Page 128 | Male Transition Elbow 90°
Codo de Transición de 90° Macho



493504

Page 128 | Female Transition Elbow 90°
Codo de Transición de 90° Hembra



492604

Page 129 | Male Transition Elbow 45°
Codo de Transición de 45° Macho



493604

Page 129 | Female Transition Elbow 45°
Codo de Transición de 45° Hembra



494104

Page 130 | Female Free Nut Transition Coupler
Enlace de Transición Tuerca Libre Hembra



494504

Page 130 | Female Transition Elbow 90°
Codo de Transición de 90° Tuerca Libre, Hembra



494604

Page 131 | Female Free Nut Transition Elbow 45°
Codo de Transición de 45° Tuerca Libre Hembra



494404

Page 131 | Female Union Free Nut Transition Tee
Enlace T PE/Latón Tuerca Libre Hembra



497104

Page 132 | PE Male Transition Coupler
Enlace de Transición PE Macho



497504

Page 132

PE Male Transition Elbow 90°
Codo de Transición PE de 90°
Macho



497604

Page 133

PE Male Transition Elbow 45°
Codo de Transición PE de 45°
Macho



497704

Page 133

PE Cast Iron Flange
Transition Coupler
Enlace de Transición
Bridado - PE/Hierro Fundido



495704

Page 134

PE Cast Iron Spigot
Transition Coupler
Enlace de Transición Espiga
- PE/Hierro Fundido



490209

Page 134

Full Face Flange
Brida de Cara Plana



490207

Page 135

Stub Flange
Adaptador de Brida



09903

Page 136

Flange Backing Ring
Brida Revestida



Wastewater Line

475804

Page 138

Wastewater Adjustable
Saddle
Ramal para Aguas
Residuales



4758A4

Page 138

Wastewater Saddle 45° Inlet
110
Ramal 45° de Salida para
Aguas Residuales



4758V4

Page 139

Wastewater Saddle PVC/PP
Adaptor Inlet
Collarin Lightfit de transicion para
Aguas Residuales de PE A PP/PVC



4758S4

Page 139

Wastewater Saddle Spigot
Inlet
Collarin Lightfit para aguas
residuales con salida espiga



4747D4

Page 140

Wastewater Adjustable
Elbow One Sided
Codo Ajustable para Aguas
Residuales Enlace/Espiga



37020/477207

Page 140

Wastewater Manhole
Adaptor
Adaptador para Pozo de
Aguas Residuales



4701V4

Page 141

Wastewater PE to PVC
Adaptor
Adaptador Para PE A PVC



4747V4

Page 141

Wastewater Adjustable
Elbow PE to PVC
Codo Ajustable de
Transición de PE a PVC



470604

Page 142

Wastewater Elbow 45°
Codo 45° Para Aguas
Residuales



473304

Page 142

Wastewater Elbow 30°
Codo 30° Para Aguas
Residuales



473704

Page 142 | Wastewater Elbow 15°
Codo 15° Para Aguas Residuales



Page 160 | Key for Tapping Saddle
Llave para Toma de Servicio



Controllers

29143.0308S324

Page 147 | PolyCode (USB + Bluetooth)
Page 151 | PolyCode (USB)



Page 160 | Rotational Scraper Tools
Raspatubos Giratorios



29143.F0318V112

Page 147 | PolyControl Plus (USB + Bluetooth) V2.0
Page 152-153 | PolyControl Plus (USB) V2.0



Page 161 | Plasson Scraper Tool for Pipe Ends
Raspatubos Giratorio Plasson



29143.0307.103

Page 148 | Polymatic Plus (USB + Bluetooth)
Page 154-155 | Polymatic Plus (USB)



Page 161 | Pipe Cutter
Cortadores de Tubería



29143.0308T108

Page 148 | Tiny Data MF (USB + Bluetooth)
Page 156-157 | Tiny Data MF (USB)



Page 161 | Rotational Pipe Cutter (S-Type)
Cortador de Tubería Giratorio (Tipo S)



29143.0307.000

Page 149 | Monomatic Data (USB + Bluetooth)
Page 158-159 | Monomatic Data (USB)



Page 161 | Rotational Pipe Cutters
Cortador de Tubería Giratorio



Installation Tools

Page 160 | Extension Key for Tapping Valve
Llave de Extensión para Toma de Servicio Con Válvula





Page 162 | Squeeze - Off Tools
Prensatubos





Page 163	Rounding Rings Redondeadores	
----------	---------------------------------	-----------------------------------------------------------------------------------

Page 163	Detergents Detergentes	
----------	---------------------------	-----------------------------------------------------------------------------------

Page 163	Markers Marcadores	
----------	-----------------------	-----------------------------------------------------------------------------------

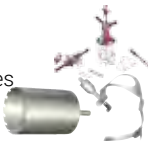
Page 164	Rounding Tool Redondeador hidráulico	
----------	-----------------------------------------	------------------------------------------------------------------------------------

Page 164	Tools for Wastewater Saddles Herramientas para enlaces para aguas residuales	
----------	---------------------------------------------------------------------------------	-------------------------------------------------------------------------------------

Page 165	Rotational Scraper Tools Rascador giratorio para tuberías de PEAD	
----------	----------------------------------------------------------------------	-------------------------------------------------------------------------------------

Page 165	Electrical Saddle Scraper Rascador eléctrico para tuberías de PEAD	
----------	-----------------------------------------------------------------------	-------------------------------------------------------------------------------------

Page 165	Core Drill Kit for Plasson-Saddle Outlet	
----------	------------------------------------------	-------------------------------------------------------------------------------------

Page 165	Drilling Machine	
----------	------------------	-------------------------------------------------------------------------------------

Page 165	Pressure Test Pump	
----------	--------------------	-------------------------------------------------------------------------------------

Page 166	Hot Tapping Tool	
----------	------------------	-------------------------------------------------------------------------------------

Page 166	Saddle Pressing Tool	
----------	----------------------	-------------------------------------------------------------------------------------

Page 166	Saddle Clamping Tool	
----------	----------------------	--------------------------------------------------------------------------------------

Page 166	Saddle Clamping Tool	
----------	----------------------	---------------------------------------------------------------------------------------

Page 167	Saddle Pressing and Clamping Tools Herramientas necesarias para la instalación de Collarines de derivación y transición de gran diámetro	
----------	---------------------------------------------------------------------------------------------------------------------------------------------	---------------------------------------------------------------------------------------

Page 168	Core cutters- for each outlet size Brocas campana para cada diámetro	
----------	-------------------------------------------------------------------------	---------------------------------------------------------------------------------------

Coupler

490104

Enlace Recto



20mm up to 75mm

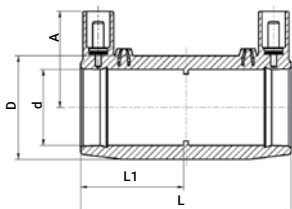

90mm up to 355mm

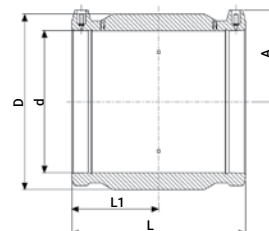

Product Code	Size d	L	L1	D	A	UC	W
490104016	16	71	34	35	39	480	58
490104020	20	76	37	31	34	440	50
490104025	25	82	40	36	37	360	40
490104032	32	88	42	44	42	256	63
490104040	40	97	47	56	46	200	97
490104050	50	101	49	67	51	132	147
490104063	63	117	57	82	57	72	230
490104075	75	126	61	98	64	60	340
490104090	90	148	73	112	71	38	566
490104110	110	163	80	135	81	23	718
490104125	125	173	85	157	87	18	1075
490104140	140	183	90	174	97	12	1295
490104160N	160	195	93	194	105	6	1550
490104180N	180	212	105	218	116	5	2112
490104200N	200	223	109	242	126	4	2785
490104225N	225	240	119	272	138	4	3900
490104250	250	251	123	301	156	2	4461
490104280	280	275	134	342	170	1	6440
490104315	315	282	139	387	184	1	8845
490104355	355	277	137	431	203	1	10200
490103400	400	293	145	485	231	1	13800

490103

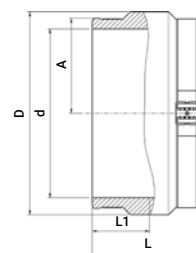

Product Code	Size d	L	L1	D	A	UC*	W
490103450	450	306	153	539	257	1	15800
490103500	500	340	170	603	283	1	20200
490103560	560	376	188	674	317	1	28000
490103630	630	418	209	759	356	1	39200
490103710	710	472	236	853	400	1	55700
490103800	800	500	250	955	450	1	87000

* Due to product size, cannot be packed in standard carton | * Cantidad óptima para embalaje en dos pallets apilados

Long Coupler

4901L4

Enlace Largo

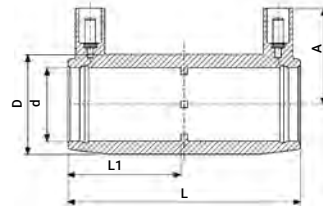

Product Code	Size d	L	L1	D	A	UC	W
4901L4032	32	104	50	44	43	272	84
4901L4040	40	121	59	56	46	128	135
4901L4050	50	139	68	68	51	96	215
4901L4063	63	166	81	82	57	48	317

Coupler (PN 25)

450104

Enlace Recto (PN 25)

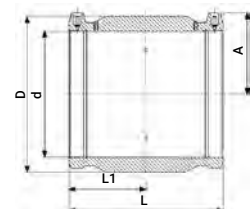
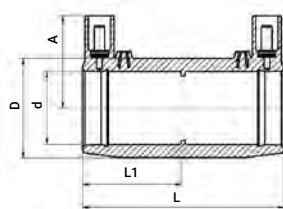

Product Code	Size d	L	L1	D	A	UC	W
450104050	50	100	49	68	52	132	147
450104063	63	118	57	82	58	72	230
450104075	75	126	62	97	65	60	339
450104090	90	148	73	117	69	38	571
450104110	110	163	80	140	79	23	835
450104125	125	173	85	157	87	18	1075
450104160	160	198	97	198	105	6	1780
450104180	180	212	104	224	114	4	2449
450104200	200	223	110	249	126	4	3295
450104225	225	240	118	280	140	4	4366
450104250	250	256	127	310	155	2	5507
450104280	280	274	135	341	166	1	6369
450104315	315	284	140	381	184	1	8884

LightFit Coupler (PN10)

460104

Enlace LightFit (PN10)

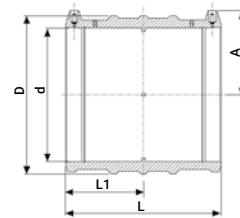

Product Code	Size d	L	L1	D	A	UC	W
460104040	40	90	43	56	47	200	96
460104050	50	100	49	68	52	132	98
460104063	63	118	57	77	57	112	157
460104075	75	126	61	90	63	60	215
460104090	90	148	72	108	69	44	360
460104110	110	163	80	131	79	25	540
460104125	125	173	85	149	87	20	740
460104140	140	182	89	167	94	12	970
460104160	160	198	97	193	104	6	1320
460104180	180	212	104	215	114	5	1650
460104200	200	232	114	235	127	4	2100
460104225	225	240	118	264	141	4	2825
460104250	250	256	126	293	155	2	3728
460104280	280	275	135	332	166	1	4850
460104315	315	284	140	374	184	1	6950
460104355	355	280	138	421	204	1	7980
460104400	400	296	146	474	227	1	11893

460103*

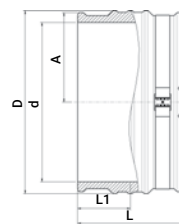

Product Code	Size d	L	L1	D	A	UC*	W
460103450	450**	310	155	518	255	1	11700
460103500	500**	340	170	576	283	1	16000
460103560	560	376	188	645	317	1	21500
460103630	630	418	209	726	356	1	30820
460103710	710	472	236	817	400	1	43100
460103800	800	500	250	913	450	1	57300
460103900	900	500	250	1031	500	1	70000

* Due to product size, cannot be packed in standard carton | * Cantidad óptima para embalaje en dos pallets apilados

** Without Straps | ** Sin correas

Super LightFit (PN 6.4)

4601S3

Super LightFit (PN 6.4)

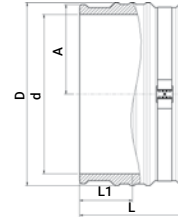

Product Code	Size d	L	L1	D	A	UC	W
4601S3500	500	300	150	550	272	1	11800
4601S3560	560	310	155	620	310	1	15300
4601S3630	630	320	160	693	346	1	18200
4601S3710	710	380	190	775	388	—	—
4601S3800	800	400	200	876	438	1	34700

Reducing Coupler

491104

Enlace Reductor

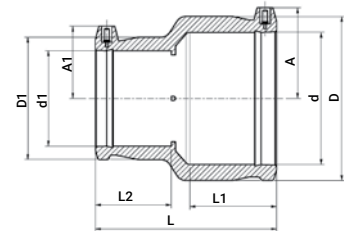
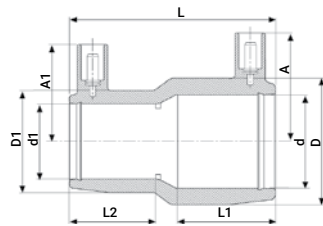

20x16mm up to 110x90mm

125x90mm up to 180x125mm

Product Code	Size dx d1	L	A	A1	L1	L2	D	D1	UC	W
491104020016	20 x 16	71	39	39	35	35	36	36	480	54
491104025020	25 x 20	71	39	39	35	35	36	36	480	46
491104032020	32 x 20	81	43	37	40	35	45	32	360	59
491104032025	32 x 25	81	43	39	40	35	45	36	360	56
491104040025	40 x 25	90	47	38	44	40	56	37	200	85
491104040032	40 x 32	90	47	43	44	40	56	44	160	92
491104050025	50 x 25	100	52	41	49	41	68	37	160	118
491104050032	50 x 32	100	52	45	49	40	68	45	128	123
491104050040	50 x 40	100	52	48	49	44	68	56	128	135
491104063032	63 x 32	119	59	45	57	40	82	45	96	179
491104063040	63 x 40	119	59	49	57	44	82	56	96	192
491104063050	63 x 50	119	59	54	57	49	82	68	80	223
491104075063	75 x 63	126	66	59	66	57	98	82	65	314
491104090050	90 x 50	143	78	53	71	49	116	69	54	430
491104090063	90 x 63	143	78	61	71	57	116	82	44	460
491104090075	90 x 75	143	78	67	71	61	116	98	41	480
491104110063	110 x 63	161	84	61	78	57	139	82	32	639
491104110090	110 x 90	161	84	74	78	72	139	116	23	740
491104125090	125 x 90	171	88	70	85	72	158	116	18	1019
491104125110	125 x 110	171	88	80	85	78	158	141	18	1025
491104160090	160 x 90	193	105	69	94	72	199	116	12	1440
491104160110	160 x 110	193	105	80	94	81	199	141	12	1520
491104160125	160 x 125	195	105	89	94	85	199	158	6	1570
491104180125	180 x 125	212	116	87	103	85	222	158	6	2060

Spigot Reducer

491107

Reductor Espiga

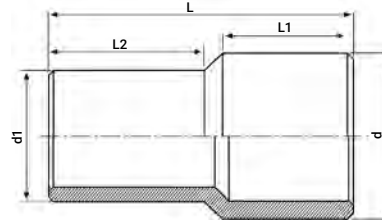

Product Code	Size dxd1	L	L1	L2	UC	W
491107032025	32 x 25	104	50	48	240	30
491107040032	40 x 32	123	59	56	240	90
491107050032	50 x 32	129	59	56	160	80
491107050040	50 x 40	131	59	60	264	100
491107063032	63 x 32	131	59	58	144	110
491107063040	63 x 40	132	59	58	144	120
491107063050	63 x 50	132	60	60	128	125
491107075040	75 x 40	145	71	60	96	167
491107075050	75 x 50	145	71	59	96	180
491107075063	75 x 63	151	71	65	72	210
491107090050	90 x 50	156	81	59	56	280
491107090063	90 x 63	160	80	65	48	300
491107090075	90 x 75	166	80	71	40	320
491107110063	110 x 63	167	83	66	36	450
491107110075	110 x 75	169	83	72	36	460
491107110090	110 x 90	178	83	80	28	510
491107125090	125 x 90	186	90	81	24	655
491107125110	125 x 110	188	90	84	18	730
491107140090	140 x 90	208	95	80	16	850
491107140110	140 x 110	195	95	83	16	850
491107140125	140 x 125	199	95	89	12	950
491107160110	160 x 110	219	101	84	10	1150
491107160125	160 x 125	206	101	88	16	1170
491107160140	160 x 140	211	101	94	10	1270
491107180125	180 x 125	221	107	89	10	1500
491107180140	180 x 140	224	107	95	10	1600
491107180160	180 x 160	225	107	100	8	1750
491107200140	200 x 140	229	114	93	8	2200
491107200160	200 x 160	233	115	100	6	2180
491107200180	200 x 180	241	116	106	5	2350
491107225160	225 x 160	295	132	123	—	3120
491107225180	225 x 180	285	130	118	—	3320
491107225200	225 x 200	272	126	120	—	3255
491107250160	250 x 160	308	149	100	—	3705
491107250180	250 x 180	316	151	105	—	4050
491107250200	250 x 200	324	151	116	—	4380
491107250225	250 x 225	330	155	122	—	4850
491107280200	280 x 200	345	140	116	—	5850
491107280225	280 x 225	335	142	122	—	6085
491107280250	280 x 250	340	139	135	—	6540
491107315225	315 x 225	365	150	125	—	7900
491107315250	315 x 250	365	147	134	—	8100
491107315280	315 x 280	365	150	145	—	8800
491107355250	355 x 250	390	164	136	—	9100
491107355280	355 x 280	390	164	139	—	9500
491107355315	355 x 315	390	164	150	—	9890
491107400280	400 x 280	415	179	139	—	10420
491107400315	400 x 315	415	179	150	—	11130
491107400355	400 x 355	420	179	164	—	11580

Maximum Pressure: PN 16 (cold water) | Presión Máxima: PN 16 (agua fría)

Additional dimensions and pressure rated spigots are available upon request

Los tamaños y presiones no enunciados en la tabla están disponibles a pedido

Flex Restraint

49009

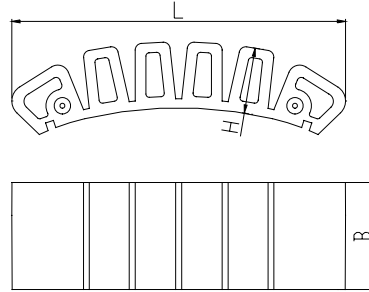

Product Code	Size	L	H	B	UC	W
49009999	160-1600	202	40	65	60	251

Flex Restraint

49009

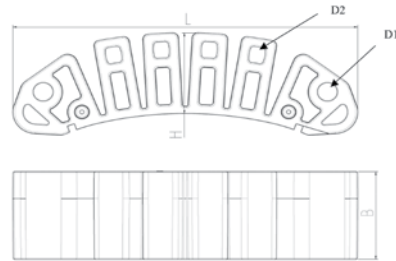

Product Code	Size	L	H	B	UC	W
49009998	160-1600	237	60	65	-	-

Monolithic End Cap

494204

Tapón Monolítico

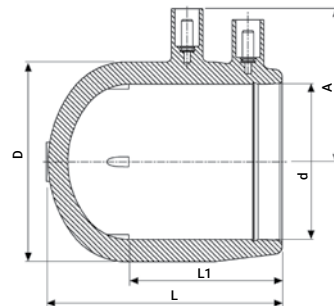

Product Code	Size d	L	L1	D	A	UC	W
494204032	32	63	44	44	46	432	50
494204040	40	70	48	55	51	256	75
494204050	50	82	55	68	56	192	122
494204063	63	95	62	81	62	96	181

End Cap

491204

Tapón

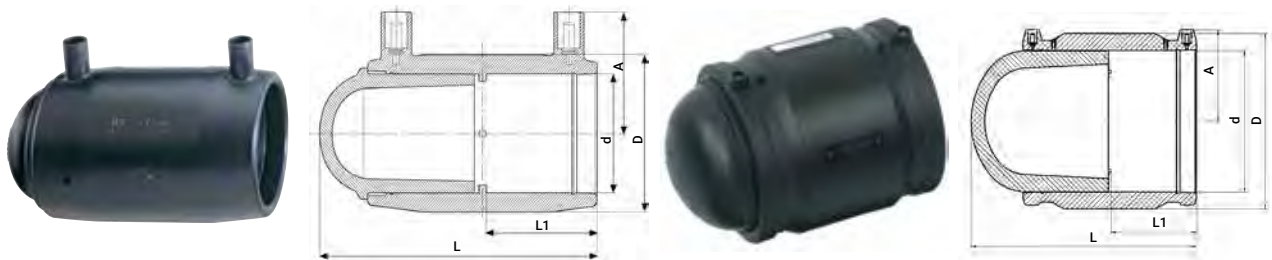

20mm up to 75mm

90mm up to 315mm

Product Code	Size d	L	L1	D	A	UC	W
491204020	20	84	37	31	34	400	55
491204025	25	92	40	36	37	400	50
491204032	32	103	42	44	42	300	76
491204040	40	114	47	56	46	160	130
491204050	50	121	49	67	51	120	204
491204063	63	142	57	82	57	72	327
491204075	75	156	61	98	64	48	499
491204090	90	183	73	117	70	30	820
491204110	110	206	78	140	81	20	1259
491204125	125	222	85	157	87	15	1702
491204140	140	237	90	174	97	10	2346
491204160	160	261	93	194	105	6	2990
491204180	180	283	105	218	116	5	4159
491204200	200	289	109	242	126	4	5260
491204225	225	318	119	272	138	2	7260
491204250	250	344	123	311	156	1	8381
491204280	280	396	134	340	170	1	11740
491204315	315	405	139	387	184	2	16045

* Less than 1 per master, meaning per large master

Spigot End Plug

491207

Tapón Espiga

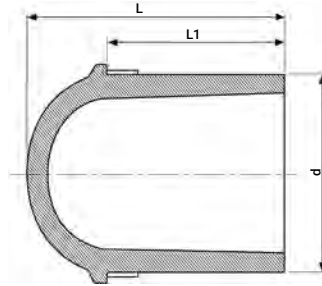

Product Code	Size d	L	L1	UC	W
491207020	20	43	35	2000	8
491207025	25	46	36	1600	10
491207032	32	52	39	960	17
491207040	40	59	43	560	29
491207050	50	68	48	352	52
491207063	63	81	57	192	94
491207075	75	90	60	132	149
491207090	90	105	70	72	250
491207110	110	121	78	57	430
491207125	125	131	82	36	596
491207140	140	142	87	25	797
491207160	160	157	94	18	1149
491207180	180	172	101	14	1600
491207200	200	178	112	10	2089
491207225	225	196	120	6	2800
491207250	250	216	130	4	3920
491207280	280	257	162	3	5300
491207315	315	262	167	2	7200

Tee 90°

490404

Enlace T 90°

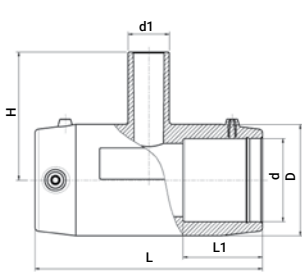

20mm up to 75mm

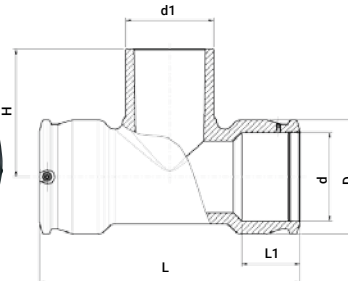

90mm up to 250mm

Product Code	Size dxd1xd	L	L1	D	H	A	UC	W
490404020	20 x 20 x 20	96	37	33	60	39	260	60
490404025	25 x 25 x 25	103	39	44	66	43	168	109
490404032	32 x 32 x 32	104	39	44	74	43	144	96
490404040	40 x 40 x 40	120	43	56	90	47	96	165
490404050	50 x 50 x 50	139	48	68	102	52	56	257
490404063	63 x 63 x 63	167	58	82	119	58	32	417
490404075	75 x 75 x 75	196	63	96	129	62	26	638
490404090	90 x 90 x 90	294	71	113	137	71	15	1090
490404110	110 x 110 x 110	326	71	143	160	81	8	1955
490404125	125 x 125 x 125	382	86	165	177	88	4	2950
490404160	160 x 160 x 160	440	86	208	206	106	3	4700
490404180	180 x 180 x 180	422	106	245	250	116	1	7200
490404200	200 x 200 x 200	451	114	261	265	125	1	8650
490404225	225 x 225 x 225	494	122	293	290	140	1	11860
490404250	250 x 250 x 250	538	129	326	315	152	1	16250

Two Outlets Reducing Tee

492404

Enlace te Reductor con Salida Doble

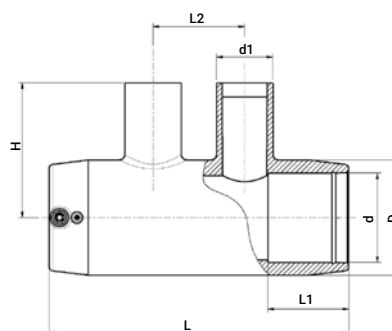

Product Code	Size dxd1 - d1xd	L	L1	L2	D	H	A	UC	W
492404040025	40 x 25 - 25 x 40	176	46	57	56	72	46	96	229
492404040032	40 x 32 - 32 x 40	176	46	57	56	76	46	75	233
492404050025	50 x 25 - 25 x 50	195	49	65	68	79	51	56	342
492404050032	50 x 32 - 32 x 50	195	49	65	68	83	51	58	336
492404050040	50 x 40 - 40 x 50	195	49	65	68	89	51	52	352
492404063025	63 x 25 - 25 x 63	213	58	65	82	86	57	42	457
492404063032	63 x 32 - 32 x 63	213	58	65	82	90	57	40	464
492404063040	63 x 40 - 40 x 63	213	58	65	82	96	57	36	480

Reducing Tee

491404

Enlace T Reductor

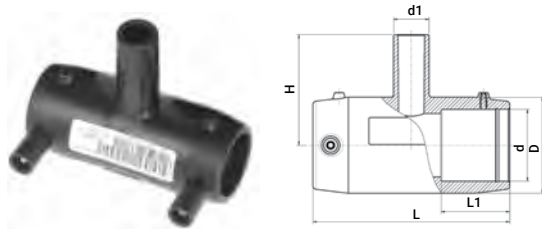

20mm up to 75mm

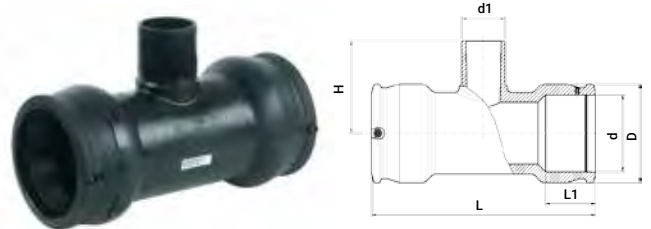

90mm up to 250mm

Product Code	Size dxd1xd	L	L1	D	H	A	UC	W
491404025020	25 x 20 x 25	104	39	44	66	43	168	108
491404025032	25 x 32 x 25	104	39	44	74	43	168	116
491404032020	32 x 20 x 32	104	39	44	66	43	144	89
491404032025	32 x 25 x 32	104	39	44	66	43	144	91
491404040020	40 x 20 x 40	120	43	56	72	47	96	151
491404040025	40 x 25 x 40	120	43	56	72	47	96	150
491404040032	40 x 32 x 40	120	43	56	75	47	96	152
491404050020	50 x 20 x 50	139	48	68	78	52	64	224
491404050025	50 x 25 x 50	139	48	68	78	52	64	225
491404050032	50 x 32 x 50	139	48	68	86	52	64	228
491404050040	50 x 40 x 50	139	48	68	90	52	64	237
491404063020	63 x 20 x 63	167	49	82	85	58	40	348
491404063032	63 x 32 x 63	167	58	82	93	58	32	353
491404063040	63 x 40 x 63	167	58	82	104	58	32	365
491404063050	63 x 50 x 63	167	58	82	109	58	32	381
491404075063	75 x 63 x 75	196	63	96	122	62	26	607
491404090063	90 x 63 x 90	294	68	113	124	71	15	1050
491404110063	110 x 63 x 110	326	71	143	134	81	9	1715
491404110090	110 x 90 x 110	326	71	143	147	81	8	1815
491404125090	125 x 90 x 125	382	86	165	161	88	5	2805
491404125110	125 x 110 x 125	382	86	165	173	88	5	2859
491404160090	160 x 90 x 160	440	86	208	180	106	3	4450
491404160110	160 x 110 x 160	440	86	208	193	106	3	4450
491404160125	160 x 125 x 160	440	86	208	198	106	3	4470
491404180090	180 x 90 x 180	422	106	245	200	116	2	6090
491404180110	180 x 110 x 180	422	106	245	219	116	2	6270
491404180125	180 x 125 x 180	422	106	245	225	116	2	6410
491404180140	180 x 140 x 180	422	106	245	237	116	1	6610
491404180160	180 x 160 x 180	422	106	245	250	116	1	6950
491404200090	200 x 90 x 200	451	114	261	205	125	2	7140
491404200110	200 x 110 x 200	451	114	261	210	125	2	7235
491404200160	200 x 160 x 200	451	114	261	400	125	—	—
491404225090	225 x 90 x 225	494	122	293	220	140	1	9900
491404225110	225 x 110 x 225	494	122	293	225	140	1	10000
491404225160	225 x 160 x 225	494	122	293	430	140	—	—
491404250090	250 x 90 x 250	538	129	326	235	152	1	13350
491404250110	250 x 110 x 250	538	129	326	240	152	1	13400
491404250160	250 x 160 x 250	538	129	326	445	152	—	—

* This size enlarges | * Esta media agranda

Flanged Tee

499404

Enlace T Bridado

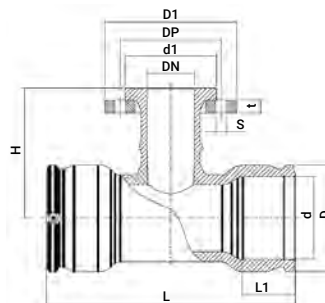

Product Code	Size d x DN x d	L	L1	D	H	A	D1	t	s	d1	DP	UC	W
499404090080	90 x 80 x 90	294	71	113	165	71	200	20	8 x 18	138	160	8	2835
499404110080	110 x 80 x 110	326	71	143	181	81	200	20	8 x 18	138	160	6	3560
499404110100	110 x 100 x 110	326	71	143	181	81	220	22	8 x 18	158	180	6	4240
499404125080	125 x 80 x 125	382	86	165	190	88	200	20	8 x 18	138	160	4	4550
499404125100	125 x 100 x 125	382	86	165	190	88	220	22	8 x 18	158	180	3	5180
499404160080	160 x 80 x 160	440	86	208	210	106	200	20	8 x 18	138	160	3	6245
499404160100	160 x 100 x 160	440	86	208	210	106	220	22	8 x 18	158	180	3	6785
499404180080	180 x 80 x 180	422	106	245	225	116	200	20	8 x 18	138	160	2	7745
499404180100	180 x 100 x 180	422	106	245	225	116	220	22	8 x 18	158	180	1	8550
499404200080	200 x 80 x 200	451	114	261	240	125	200	20	8 x 18	138	160	1	8510
499404200100	200 x 100 x 200	451	114	261	245	125	220	22	8 x 18	158	180	1	9230
499404225080	225 x 80 x 225	494	122	293	255	140	200	20	8 x 18	138	160	1	11240
499404225100	225 x 100 x 225	494	122	293	260	140	220	22	8 x 18	158	180	1	11900
499404250080	250 x 80 x 250	538	129	326	270	152	200	20	8 x 18	138	160	1	14750
499404250100	250 x 100 x 250	538	129	326	275	152	220	22	8 x 18	158	180	1	15400

Elbow 90°

490504

Codo 90°

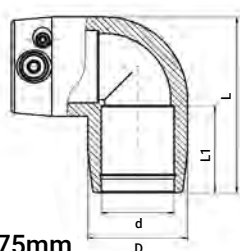

20mm up to 75mm

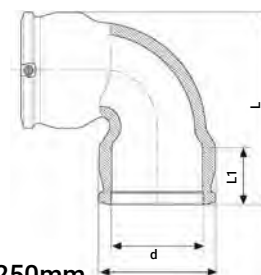

90mm up to 250mm

Product Code	Size d	L	L1	D	A	UC	W
490504020	20	66	35	36	38	320	65
490504025	25	66	37	36	38	320	52
490504032	32	83	40	44	43	192	85
490504040	40	92	44	55	47	120	137
490504050	50	108	48	68	52	72	211
490504063	63	131	57	81	59	40	320
490504075	75	158	69	97	62	33	527
490504090	90	213	78	113	69	19	875
490504110	110	243	79	143	79	9	1519
490504125	125	271	100	165	89	7	2424
490504140	140	309	93	183	94	4	3024
490504160	160	323	87	209	106	3	3990
490504180	180	412	105	244	115	2	7590
490504200	200	449	112	262	124	1	8670
490504225	225	498	121	295	140	1	12200
490504250	250	550	130	327	152	1	13500

Elbow 45°

490604

Codo 45°



32mm up to 75mm

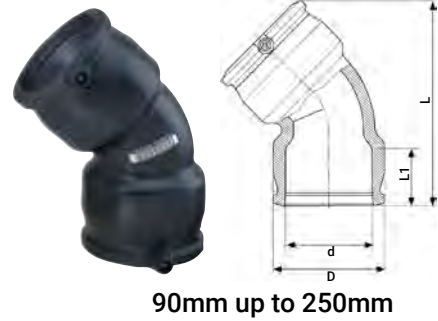

90mm up to 250mm

Product Code	Size d	L	L1	D	A	UC	W
490604032	32	95	39	45	43	240	75
490604040	40	108	42	55	46	160	117
490604050	50	125	49	68	51	96	181
490604063	63	148	57	81	59	60	263
490604075	75	180	71	96	62	40	426
490604090	90	243	75	112	69	22	759
490604110	110	271	81	143	78	12	1269
490604125	125	304	86	165	88	8	2030
490604140	140	342	92	182	95	5	2471
490604160	160	350	95	209	105	4	3990
490604180	180	434	105	244	114	2	6150
490604200	200	472	112	261	125	1	7050
490604225	225	520	120	294	140	1	9800
490604250	250	571	129	326	151	1	13400

Elbow 22.5°

490804

Codo 22.5°

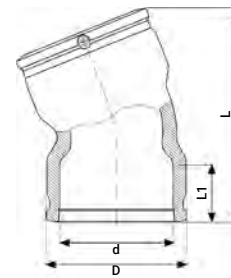

Product Code	Size d	L	L1	D	A	UC	W
490804090	90	214	72	113	71	26	665
490804110	110	232	71	143	81	14	1087
490804125	125	274	86	165	88	8	1850
490804160	160	302	86	209	106	5	2930
490804180	180	391	105	244	115	2	5360

LightFit Elbow 45°

46060

Codo LightFit 45°

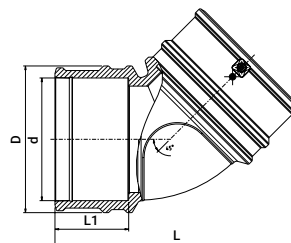

Product Code	Size d	L	L1	D	A	UC	W
460604160	160	323	98	193	106	4	1976

LightFit Elbow 30°

46330

Codo LightFit 30°

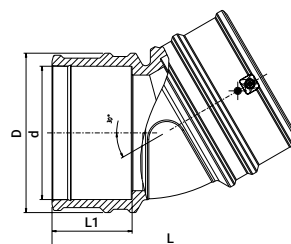

Product Code	Size d	L	L1	D	A	UC	W
463304160	160	300	98	193	106	4	1798

LightFit Elbow 15°

46370

Codo LightFit 15°

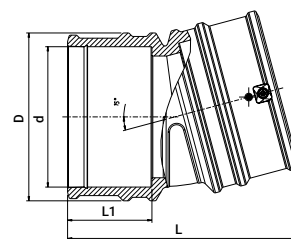

Product Code	Size d	L	L1	D	A	UC	W
463704160	160	265	98	193	106	6	1728

Elbow 180°

490904

Codo 180°

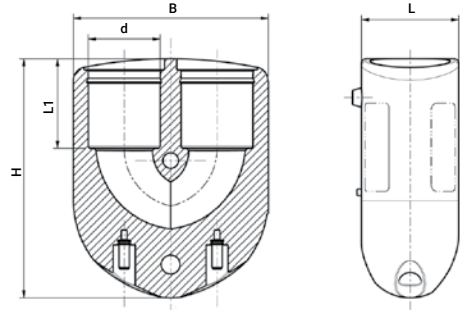

Product Code	Size d	L	L1	H	B	UC	W
490904025	25	38	38	99	72	216	163
490904032	32	44	41	108	88	144	216
490904040	40	53	48	123	106	80	323

Y Reducer

491904

Y Reductor

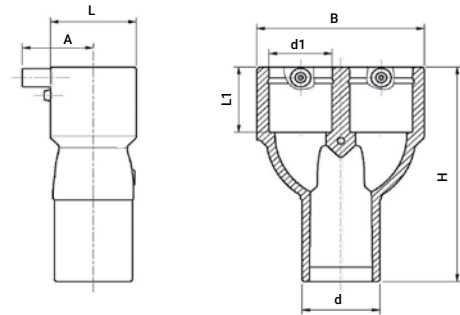

Product Code	Size d x d1 x d1	L	L1	B	A	H	UC	W
491904032025	32 x 25 x 25	36	40	70	38	119	200	97
491904040032	40 x 32 x 32	45	43	87	42	133	120	151
491904050040	50 x 40 x 40	56	46	108	46	151	72	242

Duckfoot Elbow 90°

491504

Codo 90° Empotrable

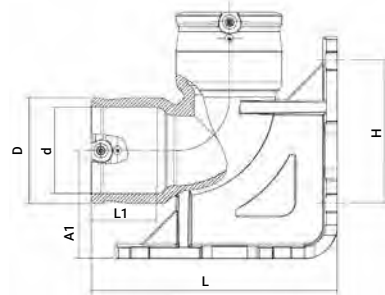

Product Code	Size d	L	L1	D	A	A1	H	UC	W
491504090	90	261	69	112	71	115	146	5	2260

Duckfoot Elbow 90° With Outlet

4915Q4

Codo 90° Emportable con toma de servicio

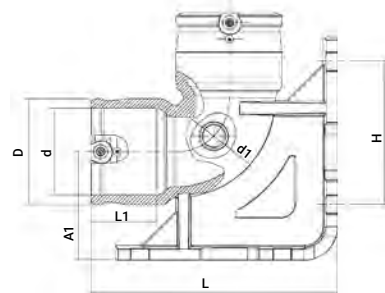

Product Code	Size d x d1	L	L1	D	A	A1	H	UC	W
4915Q4090032	90 x 32	261	69	112	71	115	146	5	2265

Adjustable Elbow

4947C4

Codo Ajustable

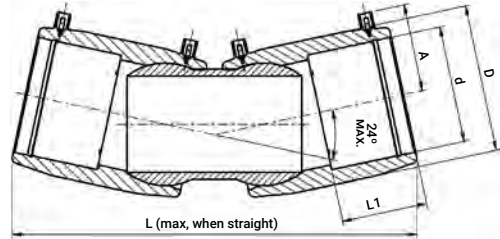

Product Code	Size d	L	L1	D	A	UC	W
4947C4090	90	341	72	116	77	12	1450
4947C4110	110	362	80	140	83	8	2030
4947C4125	125	382	85	157	95	8	2630
4947C4160	160	456	92	200	114	3	4510
4947C4180	180	511	104	224	128	2	7490
4947C4200	200	512	104	250	125	2	9733
4947C4225	225	600	105	282	141	2	13230
4947C4250	250	644	123	312	156	1	16775

Adjustable Elbow One Sided

4947D4

Codo Ajustable Enlace/Espiga

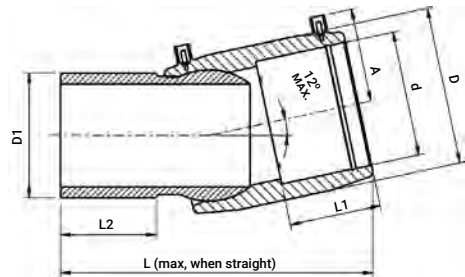

Product Code	Size d x D1	L	L1	L2	D	A	UC	W
4947D4090	90 x 90	258	72	82	116	77	20	940
4947D4110	110 x 110	276	85	85	140	83	12	1290
4947D4125	125 x 125	292	90	90	157	95	12	1740
4947D4160	160 x 160	335	100	100	200	114	4	3150
4947D4180	180 x 180	365	138	138	223	128	3	4210
4947D4200	200 x 200	370	104	116	250	125	2	6172
4947D4225	225 x 225	426	105	124	282	141	2	8340
4947D4250	250 x 250	455	123	134	312	156	1	10800

Balloon Saddle

496804

Collarín Globo

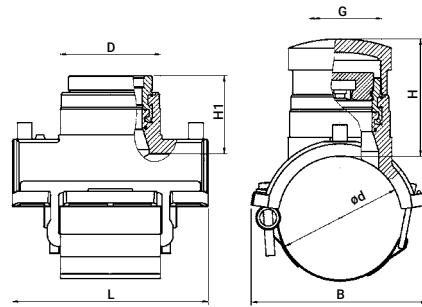

Product Code	Size d x G	B	H	H1	D	L	UC	W
496804090025	90 x 2.1/2"	142	105	70	90	176	10	1961
496804110025	110 x 2.1/2"	160	105	70	90	176	10	1973
496804125025	125 x 2.1/2"	169	105	70	90	176	10	1981
496804140025	140 x 2.1/2"	174	105	70	90	176	10	2000
496804160025	160 x 2.1/2"	176	105	70	90	176	10	1984
496804180025	180 x 2.1/2"	182	105	70	90	176	10	1997
496804200025	200 x 2.1/2"	202	105	70	90	176	10	1991
496804225025	225 x 2.1/2"	227	105	70	90	176	10	2003
496804250025	250 x 2.1/2"	252	105	70	90	176	10	2010

Monolithic Weld End Cap for Balloon Saddle

498304

Tapón Monolítico Soldable para collarín globo

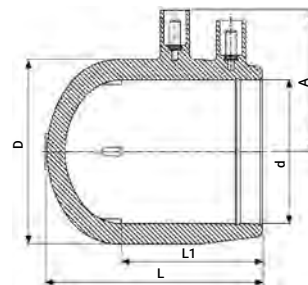

Product Code	Size d	L	L1	D	A	UC	W
498304090	90	123	77	117	77	55	479

Saddle BSPP Female Outlet

4958T4

Collarín BSPP Rosca Hembra

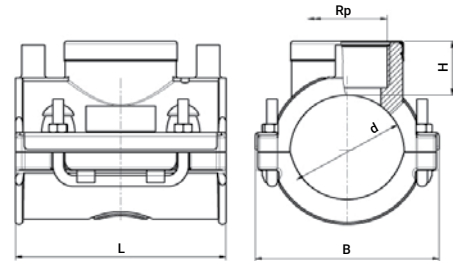

Product Code	Size d x Rp	B	H	L	UC	W
4958T4063007	63 x 3/4"	100	30	118	60	390
4958T4063010	63 x 1"	100	30	118	60	390
4958T4063013	63 x 1.1/4"	100	30	118	60	400
4958T4063015	63 x 1.1/2"	100	30	118	60	400
4958T4090010	90 x 1"	126	30	118	36	520
4958T4090013	90 x 1.1/4"	126	30	118	36	530
4958T4090015	90 x 1.1/2"	126	30	118	-	525

Repair Saddle

495204

Toma de Reparación

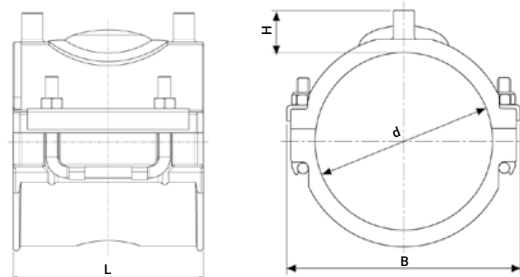

Product Code	Size d	B	H	L	UC	W
495204063	63	100	29	118	72	378
495204075	75	117	29	118	48	405
495204090	90	126	29	118	40	504
495204110	110	148	29	118	32	573
495204125	125	162	29	118	24	620
495204140	140	180	29	118	24	660
495204160	160	199	29	118	24	731
495204180	180	219	29	118	16	759

Transition Saddle

493804

Collarín de Transición



63mm up to 180mm
Outlets 1¼" and 1½"



90mm up to 250mm
Outlet 2"

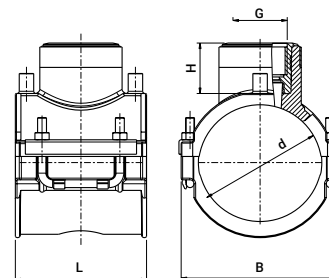

Product Code	Size d x G	B	H	L	UC	W
493804063013	63 x 1.1/4"	100	53	118	48	612
493804075013	75 x 1.1/4"	117	53	118	40	656
493804090015	90 x 1.1/2"	121	53	118	16	930
493804090020	90 x 2"	142	76	176	14	1436
493804110015	110 x 1.1/2"	142	53	118	12	1000
493804110020	110 x 2"	158	76	176	12	1500
493804125015	125 x 1.1/2"	158	53	118	12	1049
493804125020	125 x 2"	166	76	176	12	1510
493804140015	140 x 1.1/2"	175	53	118	10	1072
493804140020	140 x 2"	174	76	176	10	1520
493804160015	160 x 1.1/2"	196	53	118	8	1163
493804160020	160 x 2"	176	76	176	10	1540
493804180015	180 x 1.1/2"	216	53	118	6	1200
493804180020	180 x 2"	182	76	176	10	1500
493804200020	200 x 2"	202	76	176	10	1575
493804225020	225 x 2"	227	76	176	10	1570
493804250020	250 x 2"	252	76	176	10	1546

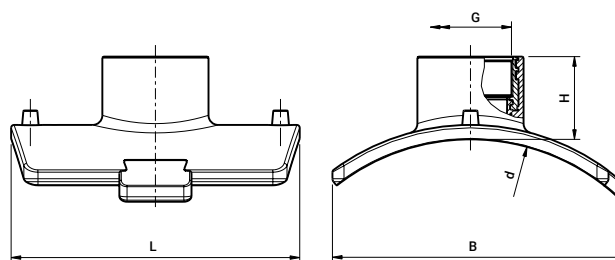

Product Code	Size d x G	B	H	L	UC	W
493804400020	250-400 x 2"	305	77	306	8	1975
493804710020	450-800 x 2"	315	77	306	8	1960

* See dedicated tools on page 167 | * Ver herramientas necesarias en pag. 167

Branch Saddle

495804

Collarín de Derivación



63mm up to 180mm
Outlets 32mm to 63mm



200mm up to 315mm
and all sizes with Outlet 90mm

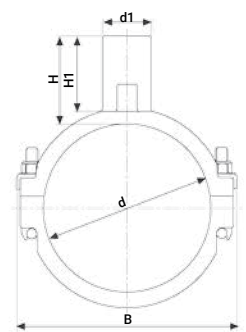
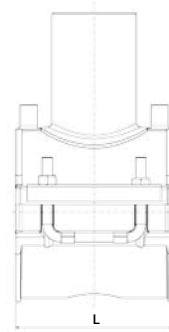

Product Code	Size d x d1	B	H	H1	L	Max Cutting Dia	UC	W
495804063032	63 x 32	100	59	49	118	23	56	394
495804063040	63 x 40	100	78	66	118	29.5	40	400
495804063050	63 x 50	100	93	82	118	37.5	40	430
495804063063	63 x 63	100	94	85	118	45	40	462
495804075032	75 x 32	117	59	49	118	23	48	431
495804075040	75 x 40	117	78	66	118	29.5	36	451
495804075050	75 x 50	117	93	82	118	37.5	32	465
495804075063	75 x 63	117	94	85	118	45	32	522
495804090032	90 x 32	126	59	49	118	23	32	519
495804090040	90 x 40	126	78	68	118	29.5	32	529
495804090050	90 x 50	126	93	82	118	37.5	32	550
495804090063	90 x 63	126	94	85	118	45	24	608
495804090090	90 x 90	139	105	90	176	66	15	934
495804110032	110 x 32	148	59	49	118	23	24	585
495804110040	110 x 40	148	78	68	118	29.5	24	598
495804110050	110 x 50	148	93	82	118	37.5	20	629
495804110063	110 x 63	148	94	85	118	45	20	658
495804110090	110 x 90	162	105	90	176	68	18	948
495804125032	125 x 32	162	59	49	118	23	24	620
495804125040	125 x 40	162	78	68	118	29.5	20	613
495804125050	125 x 50	162	93	82	118	37.5	20	690
495804125063	125 x 63	162	94	85	118	45	16	721
495804125090	125 x 90	169	105	90	176	68	18	953
495804140032	140 x 32	180	59	49	118	23	24	689
495804140040	140 x 40	180	78	68	118	29.5	16	664
495804140050	140 x 50	180	93	82	118	37.5	16	721
495804140063	140 x 63	180	94	85	118	45	16	736
495804140090	140 x 90	174	105	90	176	68	16	965
495804160032	160 x 32	200	59	49	118	23	16	708
495804160040	160 x 40	200	78	68	118	29.5	16	722
495804160050	160 x 50	200	93	82	118	37.5	16	787
495804160063	160 x 63	200	94	85	118	45	16	825
495804160090	160 x 90	176	105	90	176	68	16	956
495804180032	180 x 32	219	59	49	118	23	16	800
495804180040	180 x 40	219	78	68	118	29.5	12	800
495804180050	180 x 50	219	93	82	118	37.5	12	828
495804180063	180 x 63	219	94	85	118	45	12	886
495804180090	180 x 90	182	105	90	176	68	15	976
495804200063	200 x 63	202	102	85	176	47	15	862
495804200090	200 x 90	202	105	90	176	68	15	900
495804225063	225 x 63	227	102	85	176	47	15	930
495804225090	225 x 90	227	105	90	176	68	15	983
495804250063	250 x 63	252	102	85	176	47	15	970
495804250090	250 x 90	252	105	90	176	68	15	990
495804280090	280 x 90	282	105	90	176	68	15	990
495804315090	315 x 90	317	105	90	176	68	15	990

Branch Saddle

495804

Collarín de Derivación

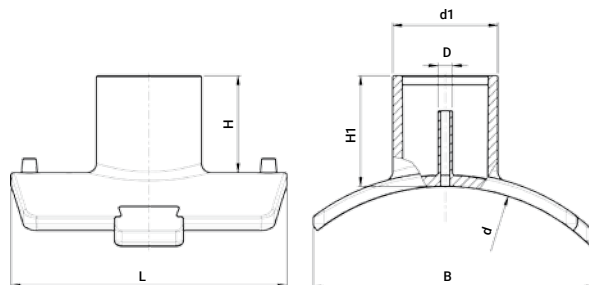

Product Code	Size d x d1	B	H	H1	L	UC	W
495804400090T	250 - 400 x 90	305	102	115	300	7	1510
495804400110T	250 - 400 x 110	305	104	117	300	7	1650
495804400125T	250 - 400 x 125	305	119	110	300	6	1680
495804400160T	280 - 400 x 160	305	119	132	300	6	2167
495804710090T	450 - 800 x 90	315	105	117	300	7	1598
495804710110T	450 - 800 x 110	315	105	117	300	7	1601
495804710125T	450 - 800 x 125	315	109	117	300	7	1739
495804710160T	450 - 800 x 160	315	115	130	300	6	2017

* See dedicated tools on page 167 | * Ver herramientas necesarias en pag. 167

XL&XXL Branch Saddle*

NEW!

495803

XL&XXL Collarín de Derivación

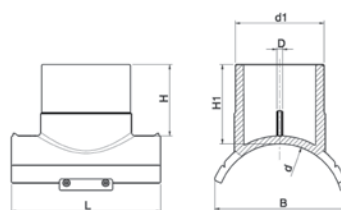

Product Code	d x d1	B	L	H	H1	D	UC	W
495803400250T	400 x 250	390	420	140	200	16	1	7400
495803450250T	450 x 250	386	460	160	198	16	1	7500
495803500315T	500 x 315	480	540	180	227	16	1	13500
495803630250T	500 - 630 x 250	400	420	203	225	16	1	6670
495803560315T	560 x 315	472	540	180	227	16	1	14000
495803560400T	560 x 400	505	620	209	258	16	1	20100
495803630315T	630 x 315	481	540	180	227	16	1	20000
495803630400T	630 x 400	520	620	209	258	16	1	20400
495803900125T	900 x 125*	320	300	110	130	16	1	—
495803900250T	900 x 250*	425	487	160	207	16	1	7000

* Water rating pressure PN10

* See dedicated tools on page 167 | * Ver herramientas necesarias en pag. 167

LightFit Branch Saddle

NEW!

4758W

Collarín de Derivación LightFit

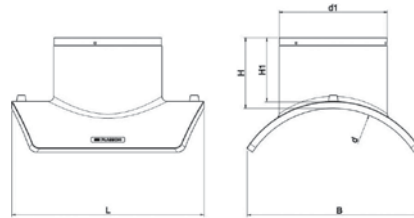

Product Code	d x DN	B	L	H	H1	UC	W
4758W4450225	315 - 450 x 225	359	145	130	400	1	3700
4758W4630225	450 - 630 x 225	389	145	130	400	1	3740
4758W4800225	630 - 800 x 225	407	145	130	400	1	3835

Flange Branch Saddle

495904

Collarín bridado

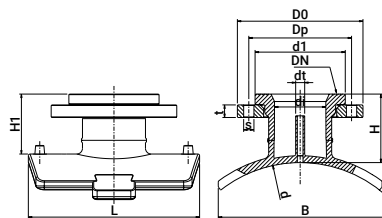

Product Code	d x DN	Flange Type	B	L	H	H1	dt	DO	Dp	di	d1	t	s	No. Holes	UC	W
495904400080T	250 - 400 x 80	ISO/DIN PN 10/16	305	300	115	105	16	200	160	71	138	20	18	8	1	2930
495904710080T	450 - 800 x 80	ISO/DIN PN 10/16	315	300	117	105	16	200	160	71	138	20	18	8	1	2960
495904400100T	250 - 400 x 100	ISO/DIN PN 10/16	305	300	121	110	16	200	180	99	158	22	18	8	1	3390
495904710100T	450 - 800 x 100	ISO/DIN PN 10/16	315	300	123	110	16	200	180	99	158	22	18	8	1	3350
495904400150T	250 - 400 x 150	ISO/DIN PN 10/16	305	300	132	120	16	285	240	127	212	24	18	8	1	6330
495904710150T	450 - 800 x 150	ISO/DIN PN 10/16	315	300	132	120	16	285	240	127	212	24	18	8	1	6300
495903900150T	900 x 150	ISO/DIN PN 10/16	-	-	-	-	16	285	240	127	212	24	18	8	1	-
495903400200T	400 x 200	ISO/DIN PN 16	377	470	210	175	16	344	295	159	268	28	22	12	1	-
495903450200T	450 x 200	ISO/DIN PN 16	387	470	210	175	16	344	295	159	268	28	22	12	1	-
495903500200T	500 x 200	ISO/DIN PN 16	398	470	210	175	16	344	295	159	268	28	22	12	1	-
495903560200T	560 x 200	ISO/DIN PN 16	400	470	210	175	16	344	295	159	268	28	22	12	1	-
495903630200T	630 x 200	ISO/DIN PN 16	405	470	210	175	16	344	295	159	268	28	22	12	1	-
495903710200T	710 x 200	ISO/DIN PN 16	410	470	210	175	16	344	295	159	268	28	22	12	1	-
495903800200T	800 x 200	ISO/DIN PN 16	410	470	210	175	16	344	295	159	268	28	22	12	1	-
495903900200T	900 x 200	ISO/DIN PN 16	415	470	210	175	16	344	295	159	268	28	22	12	1	-
495903400250T	400 x 250	ISO/DIN PN 16	390	420	230	170	16	410	355	199	320	33	26	12	1	16300
495903450250T	450 x 250	ISO/DIN PN 16	386	460	230	190	16	410	355	199	320	33	26	12	1	-
495903630250T	500 - 630 x 250	ISO/DIN PN 16	400	420	255	233	16	410	355	199	320	33	26	12	1	15400
495903710250T	710 x 250	ISO/DIN PN 16	430	470	230	190	16	410	355	199	320	33	26	12	1	-
495903800250T	800 x 250	ISO/DIN PN 16	430	470	230	190	16	410	355	199	320	33	26	12	1	-
495903900250T	900 x 250	ISO/DIN PN 16	440	470	230	190	16	410	355	199	320	33	26	12	1	-
495903450300T	450 x 300	ISO/DIN PN 16	450	530	250	210	16	467	410	251	370	40	26	12	1	-
495903500300T	500 x 300	ISO/DIN PN 16	480	540	260	210	16	467	410	251	370	40	26	12	1	-
495903560300T	560 x 300	ISO/DIN PN 16	472	540	260	210	16	467	410	251	370	40	26	12	1	-
495903630300T	630 x 300	ISO/DIN PN 16	481	540	250	210	16	467	410	251	370	40	26	12	1	-
495903710300T	710 x 300	ISO/DIN PN 16	500	530	250	210	16	467	410	251	370	40	26	12	1	-
495903800300T	800 x 300	ISO/DIN PN 16	510	530	250	210	16	467	410	251	370	40	26	12	1	-
495903900300T	900 x 300	ISO/DIN PN 16	510	530	250	210	16	467	410	251	370	40	26	12	1	-
495903560400T	560 x 400	ISO/DIN PN 16	505	620	290	240	16	595	525	319	482	54	30	16	1	-
495903630400T	630 x 400	ISO/DIN PN 16	520	620	288	239	16	595	525	319	482	54	30	16	1	-
495903710400T	710 x 400	ISO/DIN PN 16	530	610	280	240	16	595	525	319	482	54	30	16	1	-
495903800400T	800 x 400	ISO/DIN PN 16	540	610	280	240	16	595	525	319	482	54	30	16	1	-
495903900400T	900 x 400	ISO/DIN PN 16	550	610	280	240	16	595	525	319	482	54	30	16	1	-

* See dedicated tools on page 167 | * Ver herramientas necesarias en pag. 167

Repair Saddle

495204

Collarín de reparación

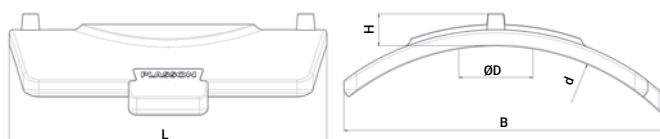

Product Code	Size d	B	H	L	D	UC	W
495204900	R215	305	30	300	70	-	1330

Tapping Saddle

496304

Toma de Servicio



40mm up to 63mm 75mm up to 180mm 200mm up to 250mm

Product Code	Type	Size d x d1	H	B	H1	H2	L	Welding Cup Type	UC	W
496304040020	mb	40 x 20	107	66	7	94	100	Type C	52	290
496304040025	mb	40 x 25	90	65	7	98	100	Type C	40	349
496304040032	mb	40 x 32	121	66	11	94	100	Type C	52	370
496304050020	mb	50 x 20	110	76	7	98	100	Type C	52	390
496304050025	mb	50 x 25	91	76	10	98	100	Type C	52	390
496304050032	mb	50 x 32	122	76	12	98	100	Type C	52	380
496304063020N	mb	63 x 20	90	100	10	90	118	Type C	40	355
496304063025N	mb	63 x 25	93	100	12	36	118	Type C	40	434
496304063032N	mb	63 x 32	99	100	12	90	118	Type C	40	380
496304063040		63 x 40	142	100	64	177	118	Type A	16	1080
496304063050		63 x 50	154	100	64	177	118	Type A	16	1099
496304063063		63 x 63	175	100	64	177	118	Type A	16	1183
496304075020		75 x 20	125	117	50	177	118	Type A	16	1120
496304075032		75 x 32	132	117	56	177	118	Type A	16	1091
496304075040		75 x 40	142	117	60	177	118	Type A	16	1124
496304075050		75 x 50	123	117	64	177	118	Type A	16	1139
496304075063		75 x 63	175	117	64	177	118	Type A	16	1228
496304090020	mb	90 x 20	117	126	16	114	118	Type B	20	900
496304090025	mb	90 x 25	108	126	16	114	118	Type B	20	1120
496304090032	mb	90 x 32	126	126	16	114	118	Type B	20	1120
496304090040	mb	90 x 40	134	126	21	114	118	Type B	20	1130
496304090050		90 x 50	123	126	64	177	118	Type A	14	1220
496304090063		90 x 63	175	126	64	177	118	Type A	14	1300
496304110020	mb	110 x 20	119	148	16	114	118	Type B	20	964
496304110025		110 x 25	118	148	16	114	118	Type B	20	964
496304110032	mb	110 x 32	127	148	16	114	118	Type B	20	970
496304110040	mb	110 x 40	138	148	21	114	118	Type B	20	1000
496304110050		110 x 50	123	148	64	177	118	Type A	12	1300
496304110063		110 x 63	175	148	64	177	118	Type A	12	1383
496304125020	mb	125 x 20	116	162	16	114	118	Type B	15	1220
496304125032	mb	125 x 32	131	162	16	114	118	Type B	15	1230
496304125040	mb	125 x 40	141	162	21	114	118	Type B	15	1280
496304125050		125 x 50	123	162	64	177	118	Type A	12	1345
496304125063		125 x 63	175	162	64	177	118	Type A	12	1420
496304140020		140 x 20	125	180	50	177	118	Type A	12	1340
496304140032		140 x 32	132	180	56	177	118	Type A	12	1330
496304140040		140 x 40	142	180	60	177	118	Type A	12	1360
496304140050		140 x 50	123	180	64	177	118	Type A	12	1382
496304140063		140 x 63	175	180	64	177	118	Type A	12	1468
496304160020	mb	160 x 20	118	199	21	138	118	Type A	10	1360
496304160032	mb	160 x 32	144	199	16	138	118	Type A	10	1320
496304160040	mb	160 x 40	157	199	21	138	118	Type A	10	1439
496304160050	mb	160 x 50	175	199	24	138	118	Type A	10	1375
496304160063	mb	160 x 63	197	199	20	138	118	Type A	10	1390

* Please note: mb = Mono Block | * Nota: mb = monobloque

Tapping Saddle

Toma de Servicio



40mm up to 63mm 75mm up to 180mm 200mm up to 250mm

Product Code	Type	Size d x d1	H	B	H1	H2	L	Welding Cup Type	UC	W
496304180020		180 x 20	125	219	50	177	118	Type A	10	1550
496304180032	mb	180 x 32	144	219	18	138	118	Type A	10	1565
496304180040	mb	180 x 40	155	219	21	138	118	Type A	10	1580
496304180050	mb	180 x 50	174	219	24	138	118	Type A	10	1595
496304180063	mb	180 x 63	197	219	20	138	118	Type A	10	1605
496304200020		200 x 20	125	202	50	177	176	Type A	8	1425
496304200032		200 x 32	132	202	56	177	176	Type A	8	1445
496304200040		200 x 40	142	202	60	177	176	Type A	8	1471
496304200050		200 x 50	123	202	64	177	176	Type A	8	1496
496304200063		200 x 63	175	202	64	177	176	Type A	8	1579
496304225020		225 x 20	125	227	50	177	176	Type A	8	1370
496304225032		225 x 32	132	227	56	177	176	Type A	8	1450
496304225040		225 x 40	142	227	60	177	176	Type A	8	1485
496304225050		225 x 50	123	227	64	177	176	Type A	8	1506
496304225063		225 x 63	175	227	64	177	176	Type A	8	1589
496304250020		250 x 20	125	252	50	177	176	Type A	8	1380
496304250032		250 x 32	132	252	56	177	176	Type A	8	1464
496304250040		250 x 40	142	252	60	177	176	Type A	8	1582
496304250050		250 x 50	123	252	64	177	176	Type A	8	1589
496304250063		250 x 50	175	252	64	177	176	Type A	8	1595

* Please note: mb = Mono Block | * Nota: mb = monobloque

Tapping Saddle Parallel Outlet

4963P4

Toma de Servicio salida Parallel Outlet

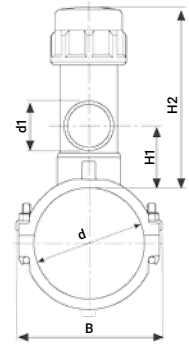
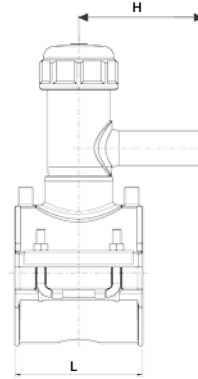

Product Code	Size d x d1	H	B	H1	H2	L	Welding Cup Type	UC	W
4963P4063020	63 x 20	125	100	50	177	118	Type A	16	1035
4963P4063032	63 x 32	132	100	56	177	118	Type A	16	1042
4963P4063040	63 x 40	142	100	60	177	118	Type A	16	1070
4963P4063050	63 x 50	123	100	64	177	118	Type A	16	906
4963P4063063	63 x 63	175	100	64	177	118	Type A	16	1180
4963P4075020	75 x 20	125	117	50	177	118	Type A	16	1120
4963P4075032	75 x 32	132	117	56	177	118	Type A	16	1130
4963P4075040	75 x 40	142	117	60	177	118	Type A	16	1119
4963P4075050	75 x 50	123	117	64	177	118	Type A	16	1140
4963P4075063	75 x 63	175	117	64	177	118	Type A	16	1226
4963P4090020	90 x 20	125	126	50	177	118	Type A	14	1170
4963P4090032	90 x 32	132	126	56	177	118	Type A	14	1120
4963P4090040	90 x 40	142	126	60	177	118	Type A	14	1130
4963P4090050	90 x 50	123	126	64	177	118	Type A	14	1235
4963P4090063	90 x 63	175	126	64	177	118	Type A	14	1270
4963P4110020	110 x 20	125	148	50	177	118	Type A	12	1240
4963P4110032	110 x 32	132	148	56	177	118	Type A	12	1175
4963P4110040	110 x 40	142	148	60	177	118	Type A	12	1179
4963P4110050	110 x 50	123	148	64	177	118	Type A	12	1293
4963P4110063	110 x 63	175	148	64	177	118	Type A	12	1380
4963P4125020	125 x 20	125	162	50	177	118	Type A	10	1275
4963P4125032	125 x 32	132	162	56	177	118	Type A	10	1298
4963P4125040	125 x 40	142	162	60	177	118	Type A	10	1320
4963P4125050	125 x 50	123	162	64	177	118	Type A	10	1335
4963P4125063	125 x 63	175	162	64	177	118	Type A	10	1426
4963P4140020	140 x 20	125	180	50	177	118	Type A	10	1340
4963P4140032	140 x 32	132	180	56	177	118	Type A	10	1330
4963P4140040	140 x 40	142	180	60	177	118	Type A	10	1360
4963P4140050	140 x 50	123	180	64	177	118	Type A	10	1370
4963P4140063	140 x 63	175	180	64	177	118	Type A	10	1468
4963P4160020	160 x 20	125	199	50	177	118	Type A	10	1390
4963P4160032	160 x 32	132	199	56	177	118	Type A	10	1304
4963P4160040	160 x 40	142	199	60	177	118	Type A	10	1327
4963P4160050	160 x 50	123	199	64	177	118	Type A	10	1348
4963P4160063	160 x 63	175	199	64	177	118	Type A	10	1399
4963P4180020	180 x 20	125	219	50	177	118	Type A	8	1550
4963P4180032	180 x 32	132	219	56	177	118	Type A	8	1304
4963P4180040	180 x 40	142	219	60	177	118	Type A	8	1490
4963P4180050	180 x 50	123	219	64	177	118	Type A	8	1515
4963P4180063	180 x 63	175	219	64	177	118	Type A	8	1304
4963P4200020	200 x 20	125	202	50	177	176	Type A	8	1360
4963P4200032	200 x 32	132	202	56	177	176	Type A	8	1451
4963P4200040	200 x 40	142	202	60	177	176	Type A	8	1405
4963P4200050	200 x 50	123	202	64	177	176	Type A	8	1425
4963P4200063	200 x 63	175	202	64	177	176	Type A	8	1510
4963P4225020	225 x 20	125	227	50	177	176	Type A	8	1370
4963P4225032	225 x 32	132	227	56	177	176	Type A	8	1450
4963P4225040	225 x 40	142	227	60	177	176	Type A	8	1485
4963P4225050	225 x 50	123	227	64	177	176	Type A	8	1506
4963P4225063	225 x 63	175	227	64	177	176	Type A	8	1586
4963P4250020	250 x 20	125	252	50	177	176	Type A	8	1380
4963P4250032	250 x 32	132	252	56	177	176	Type A	8	1569
4963P4250040	250 x 40	142	252	60	177	176	Type A	8	1582
4963P4250050	250 x 50	123	252	64	177	176	Type A	8	1589
4963P4250063	250 x 63	175	252	64	177	176	Type A	8	1595

Welding Cap for Tapping Saddle

498304

Tapón Soldable para toma de servicio

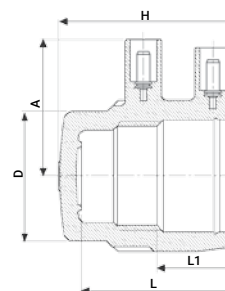

Product Code	Type	Size	D	A	H	L	L1	UC	W
498304057	Type A	57	74	59	74	63	36	128	157
498304050	Type B	50	62	54	73	66	30	192	111
498304040	Type C	40	51	49	63	55	26	256	73

* Please use Welding Cap Type as specified on page 167 | * Utilizar el tipo de tapón soldable como se indica en la página 167

PE Ball Valve

436207

Válvula de Bola PE

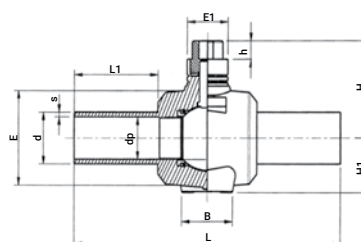

Product Code	Size d	dp	s	L	L1	B	E	E1	H	H1	h	UC	W
436207025	25*	19	3	300	103	65	80	70	94	50	40	12	705
436207032	32*	24	3	300	103	65	80	70	94	50	40	12	705
436207040	40	24	4	300	103	65	80	70	94	50	40	12	758
436207050	50*	39	6	414	130	87	120	85	160	80	40	4	2091
436207063	63*	48	6	414	130	87	120	85	160	80	40	4	2061
436207075	75	48	8	414	130	87	120	85	160	80	40	4	2293
436207090	90*	70	8	550	176	93	200	85	200	110	40	2	5865
436207110	110*	86	10	550	178	93	200	85	200	110	40	2	5761
436207125	125	86	12	550	182	93	200	85	200	110	40	2	6300
436207160	160	86	16	550	182	93	200	85	200	110	40	2	7100

* Full Bore Dimensions | * Dimensiones de cavidad única

Tapping Valve

495404

Toma de Servicio con Válvula

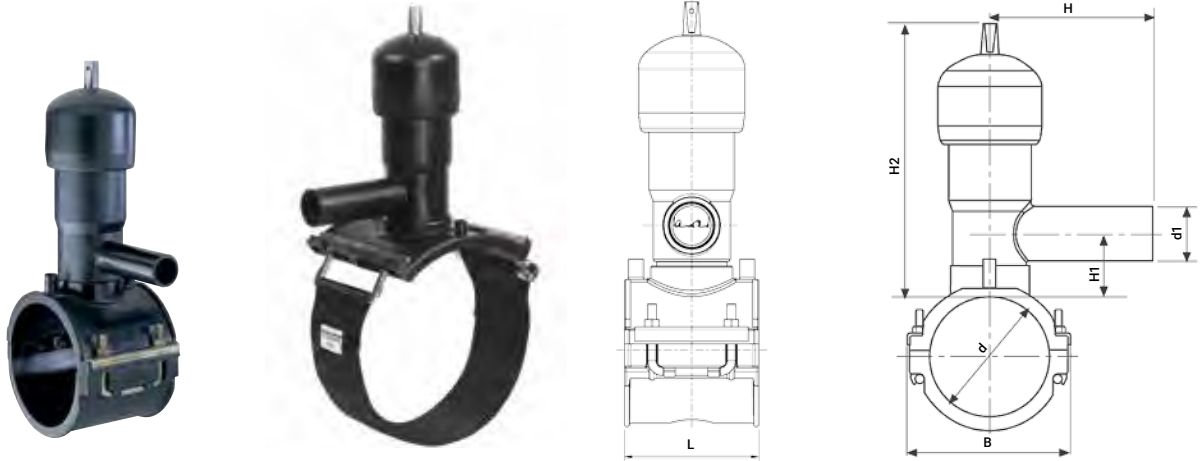

63mm up to 180mm

200mm up to 250mm

Product Code	Size d x d1	B	H	H1	H2	L	UC	W
495404063032	63 x 32	99	126	46	244	118	8	2090
495404063040	63 x 40	99	137	46	244	118	8	2103
495404063050	63 x 50	99	152	51	244	118	8	2140
495404063063	63 x 63	99	186	51	244	118	8	2205
495404075032	75 x 32	117	126	46	244	118	8	2100
495404075040	75 x 40	117	137	46	244	118	8	2113
495404075050	75 x 50	117	152	51	244	118	8	2150
495404075063	75 x 63	117	186	51	244	118	8	2215
495404090032	90 x 32	126	126	46	244	118	8	2150
495404090040	90 x 40	126	137	46	244	118	8	2163
495404090050	90 x 50	126	152	51	244	118	8	2200
495404090063	90 x 63	126	186	51	244	118	8	2265
495404110032	110 x 32	148	126	46	244	118	8	2266
495404110040	110 x 40	148	137	46	244	118	8	2250
495404110050	110 x 50	148	152	51	244	118	8	2279
495404110063	110 x 63	148	186	51	244	118	8	2345
495404125032	125 x 32	162	126	46	244	118	8	2276
495404125040	125 x 40	162	137	46	244	118	8	2289
495404125050	125 x 50	162	152	51	244	118	8	2326
495404125063	125 x 63	162	186	51	244	118	8	2391
495404140032	140 x 32	180	126	46	244	118	8	2285
495404140040	140 x 40	180	137	46	244	118	8	2298
495404140050	140 x 50	180	152	51	244	118	8	2335
495404140063	140 x 63	180	186	51	244	118	8	2441
495404160032	160 x 32	202	126	46	244	118	8	2377
495404160040	160 x 40	202	137	46	244	118	8	2390
495404160050	160 x 50	202	152	51	244	118	8	2427
495404160063	160 x 63	202	186	51	244	118	8	2492
495404180032	180 x 32	220	126	46	244	118	8	2440
495404180040	180 x 40	220	137	46	244	118	8	2453
495404180050	180 x 50	220	152	51	244	118	8	2490
495404180063	180 x 63	220	186	51	244	118	8	2550
495404200032	200 x 32	202	126	46	244	176	5	2431
495404200040	200 x 40	202	137	46	244	176	5	2444
495404200050	200 x 50	202	152	51	244	176	5	2481
495404200063	200 x 63	202	186	51	244	176	5	2546
495404225032	225 x 32	227	126	46	244	176	5	2448
495404225040	225 x 40	227	137	46	244	176	5	2501
495404225050	225 x 50	227	152	51	244	176	5	2538
495404225063	225 x 63	227	186	51	244	176	5	2603
495404250032	250 x 32	252	126	46	244	176	5	2504
495404250040	250 x 40	252	137	46	244	176	5	2517
495404250050	250 x 50	252	152	51	244	176	5	2554
495404250063	250 x 63	252	186	51	244	176	5	2619

Tapping Valve

4954S4*

Toma de Servicio con Válvula

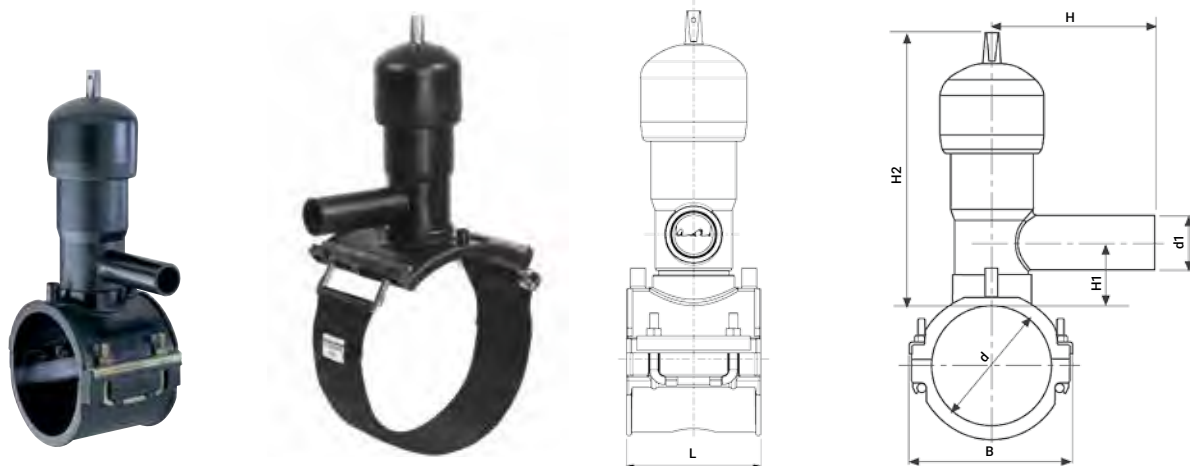

63mm up to 180mm

200mm up to 250mm

Product Code	Size d x d1	B	H	H1	H2	L	UC	W
4954S4063032	63 x 32	103	126	46	244	118	8	2100
4954S4063040	63 x 40	103	137	46	244	118	8	2113
4954S4063050	63 x 50	103	152	51	244	118	8	2150
4954S4063063	63 x 63	103	186	51	244	118	8	2215
4954S4075032	75 x 32	117	126	46	244	118	8	2110
4954S4075040	75 x 40	117	137	46	244	118	8	2123
4954S4075050	75 x 50	117	152	51	244	118	8	2160
4954S4075063	75 x 63	117	186	51	244	118	8	2225
4954S4090032	90 x 32	124	126	46	244	118	8	2160
4954S4090040	90 x 40	124	137	46	244	118	8	2173
4954S4090050	90 x 50	124	152	51	244	118	8	2210
4954S4090063	90 x 63	124	186	51	244	118	8	2275
4954S4110032	110 x 32	145	126	46	244	118	8	2277
4954S4110040	110 x 40	145	137	46	244	118	8	2260
4954S4110050	110 x 50	145	152	51	244	118	8	2290
4954S4110063	110 x 63	145	186	51	244	118	8	2355
4954S4125032	125 x 32	162	126	46	244	118	8	2287
4954S4125040	125 x 40	162	137	46	244	118	8	2300
4954S4125050	125 x 50	162	152	51	244	118	8	2337
4954S4125063	125 x 63	162	186	51	244	118	8	2402
4954S4140032	140 x 32	178	126	46	244	118	8	2295
4954S4140040	140 x 40	178	137	46	244	118	8	2308
4954S4140050	140 x 50	178	152	51	244	118	8	2345
4954S4140063	140 x 63	178	186	51	244	118	8	2410
4954S4160032	160 x 32	199	126	46	244	118	8	2387
4954S4160040	160 x 40	199	137	46	244	118	8	2400
4954S4160050	160 x 50	199	152	51	244	118	8	2437
4954S4160063	160 x 63	199	186	51	244	118	8	2502
4954S4180032	180 x 32	219	126	46	244	118	8	2450
4954S4180040	180 x 40	219	137	46	244	118	8	2463
4954S4180050	180 x 50	219	152	51	244	118	8	2500
4954S4180063	180 x 63	219	186	51	244	118	8	2565
4954S4200032	200 x 32	202	126	46	244	176	5	2441
4954S4200040	200 x 40	202	137	46	244	176	5	2454
4954S4200050	200 x 50	202	152	51	244	176	5	2491
4954S4200063	200 x 63	202	186	51	244	176	5	2556
4954S4225032	225 x 32	227	126	46	244	176	5	2498
4954S4225040	225 x 40	227	137	46	244	176	5	2511
4954S4225050	225 x 50	227	152	51	244	176	5	2548
4954S4225063	225 x 63	227	186	51	244	176	5	2613
4954S4250032	250 x 32	252	126	46	244	176	5	2514
4954S4250040	250 x 40	252	137	46	244	176	5	2527
4954S4250050	250 x 50	252	152	51	244	176	5	2564
4954S4250063	250 x 63	252	186	51	244	176	5	2629

* Tapping Valve with serrated edge knife. Available in all sizes.

* Toma de servicio con bordes "dientes de sierra". Todos los tamaños.

Male Transition Coupler

492104

Enlace de Transición Macho

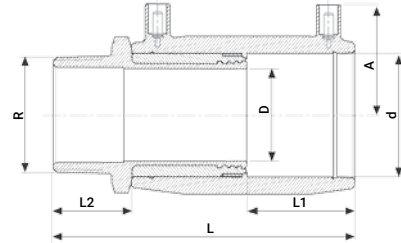

Product Code	Size d x R	L	L1	L2	D	A	UC	W
492104020005	20 x 1/2"	105	37	29	14	34	200	129
492104025007	25 x 3/4"	111	40	29	19	37	150	150
492104032005	32 x 1/2"	110	39	29	23	42	100	142
492104032007	32 x 3/4"	110	39	29	23	42	100	263
492104032010	32 x 1"	122	42	34	23	42	100	285
492104032013	32 x 1 1/4"	124	42	36	23	42	60	393
492104032015	32 x 1 1/2"	124	42	36	23	42	60	404
492104040010	40 x 1"	131	47	34	29	46	72	409
492104040013	40 x 1 1/4"	133	47	36	29	46	54	470
492104040015	40 x 1 1/2"	133	47	36	29	46	54	483
492104040020	40 x 2"	160	44	41	48	59	36	500
492104050010	50 x 1"	135	49	34	38	51	48	513
492104050013	50 x 1 1/4"	137	49	36	38	51	48	569
492104050015	50 x 1 1/2"	137	49	36	38	51	48	547
492104050020	50 x 2"	160	49	41	48	59	30	752
492104063013	63 x 1 1/4"	153	57	36	48	57	30	884
492104063015	63 x 1 1/2"	153	57	36	48	57	30	845
492104063020	63 x 2"	158	57	41	48	57	30	921
492104075020	75 x 2"	167	61	41	59	64	16	1305
492104075025	75 x 2 1/2"	172	61	46	59	64	16	1512

Female Transition Coupler

493104

Enlace de Transición Hembra

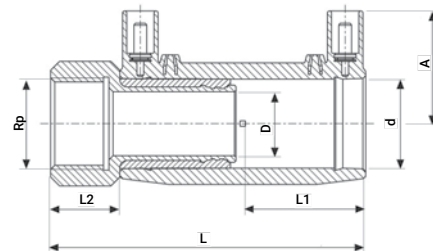

Product Code	Size d x Rp	L	L1	L2	D	A	UC	W
493104020005	20 x 1/2"	96	37	20	14	35	200	130
493104025007	25 x 3/4"	105	40	23	19	38	150	145
493104025010	25 x 1"	108	34	28	23	42	80	252
493104032007	32 x 3/4"	124	39	23	19	42	100	147
493104032010	32 x 1"	113	42	25	23	42	100	265
493104032013	32 x 1 1/4"	118	39	28	29	47	54	507
493104032015	32 x 1 1/2"	124	39	25	38	47	50	455
493104040010	40 x 1"	122	47	25	29	46	54	507
493104040013	40 x 1 1/4"	122	47	25	29	46	54	407
493104040015	40 x 1 1/2"	122	47	25	29	46	48	419
493104040020	40 x 2"	150	44	32	38	59	32	821
493104050015	50 x 1 1/2"	126	49	25	38	51	48	491
493104050020	50 x 2"	131	49	30	38	51	40	685
493104063015	63 x 1 1/2"	145	59	26	38	59	24	558
493104063020	63 x 2"	147	57	30	48	57	30	840

Male Transition Elbow 90°

492504

Codo de Transición de 90° Macho

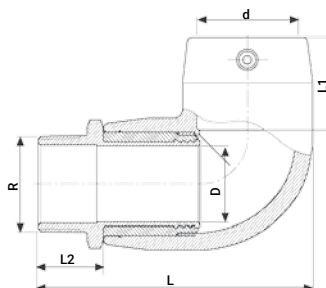

Product Code	Size d x R	L	L1	L2	D	A	UC	W
492504020005	20 x 1/2"	95	35	29	14	38	150	153
492504025007	25 x 3/4"	95	37	29	19	38	120	168
492504032005	32 x 1/2"	112	40	29	23	43	84	259
492504032007	32 x 3/4"	112	40	29	23	43	84	262
492504032010	32 x 1"	117	40	34	23	43	84	300
492504032013	32 x 1.1/4"	119	40	36	23	43	60	419
492504032015	32 x 1.1/2"	119	40	36	23	43	60	436
492504040010	40 x 1"	126	44	34	29	47	48	458
492504040013	40 x 1.1/4"	128	44	36	29	47	48	500
492504040015	40 x 1.1/2"	128	44	36	29	47	48	510
492504040020	40 x 2"	133	44	41	29	47	48	725
492504050010	50 x 1"	142	48	34	38	52	42	624
492504050013	50 x 1.1/4"	144	48	36	38	52	36	679
492504050015	50 x 1.1/2"	144	48	36	38	52	36	655
492504050020	50 x 2"	149	48	41	38	52	30	806
492504063013	63 x 1.1/4"	167	57	36	48	59	24	985
492504063015	63 x 1.1/2"	167	57	36	48	59	24	1040
492504063020	63 x 2"	172	57	41	48	59	24	1125
492504075020	75 x 2"	199	69	41	59	62	16	1450
492504075025	75 x 2.1/2"	204	69	46	59	62	16	1649

Female Transition Elbow 90°

493504

Codo de Transición de 90° Hembra

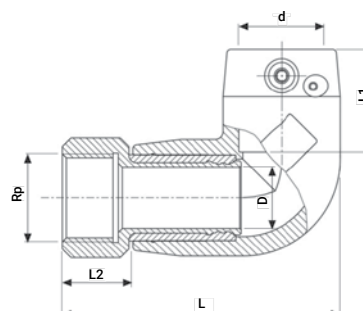

Product Code	Size d x Rp	L	L1	L2	D	A	UC	W
493504020005	20 x 1/2"	86	35	20	14	38	160	142
493504025007	25 x 3/4"	89	37	23	19	38	120	160
493504032007	32 x 3/4"	108	40	25	23	43	96	280
493504032010	32 x 1"	108	40	25	23	43	96	280
493504032015	32 x 1.1/2"	108	40	25	23	43	96	360
493504040010	40 x 1"	117	44	25	29	47	48	535
493504040013	40 x 1.1/4"	117	44	25	29	47	48	432
493504040015	40 x 1.1/2"	117	44	25	29	47	48	453
493504050015	50 x 1.1/2"	133	48	25	38	52	48	560
493504050020	50 x 2"	138	48	30	38	52	40	744
493504063015	63 x 1.1/2"	161	57	30	48	59	24	1072
493504063020	63 x 2"	161	57	30	48	59	24	959

Male Transition Elbow 45°

492604

Codo de Transición de 45° Macho

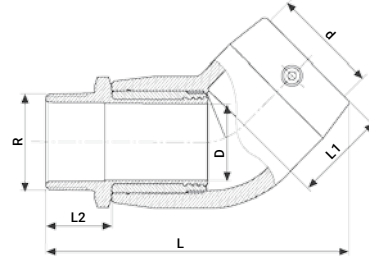

Product Code	Size d x R	L	L1	L2	D	A	UC	W
492604032005	32 x 1/2	124	39	29	23	43	84	249
492604032007	32 x 3/4	123	39	29	23	43	84	250
492604032010	32 x 1"	129	39	34	23	43	72	375
492604032013	32 x 1 1/4"	130	39	36	23	43	48	479
492604032015	32 x 1 1/2"	130	39	36	23	43	48	488
492604040010	40 x 1"	142	44	34	29	47	60	433
492604040013	40 x 1 1/4"	144	44	36	29	47	60	485
492604040015	40 x 1 1/2"	144	44	36	29	47	48	510
492604040020	40 x 2"	149	44	41	29	47	40	685
492604050010	50 x 1"	161	49	34	38	51	48	564
492604050013	50 x 1 1/4"	161	49	36	38	51	48	610
492604050015	50 x 1 1/2"	166	49	36	38	51	48	600
492604050020	50 x 2"	165	49	41	38	51	30	778
492604063013	63 x 1 1/4"	184	57	36	48	59	24	927
492604063015	63 x 1 1/2"	184	57	36	48	59	24	893
492604063020	63 x 2"	189	57	41	48	59	24	953
492604075020	75 x 2"	221	71	41	59	62	16	1399
492604075025	75 x 2 1/2"	226	71	46	59	62	16	1600

Female Transition Elbow 45°

493604

Codo de Transición de 45° Hembra

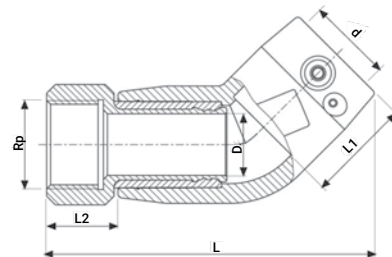

Product Code	Size d x Rp	L	L1	L2	D	A	UC	W
493604032007	32 x 3/4"	120	39	25	23	43	96	320
493604032010	32 x 1"	120	39	25	23	43	72	342
493604032015	32 x 1.1/2"	120	39	25	23	43	72	488
493604040010	40 x 1"	133	44	25	29	47	48	510
493604040013	40 x 1.1/4"	133	44	25	29	47	48	419
493604040015	40 x 1.1/2"	133	44	25	29	47	48	479
493604050015	50 x 1.1/2"	150	49	25	38	51	48	532
493604050020	50 x 2"	155	49	30	38	51	36	714
493604063015	63 x 1.1/2"	178	57	30	48	59	24	1019
493604063020	63 x 2"	178	57	30	48	59	24	912

Female Free Nut Transition Coupler*

494104

Enlace de Transición, Tuerca Libre, Hembra

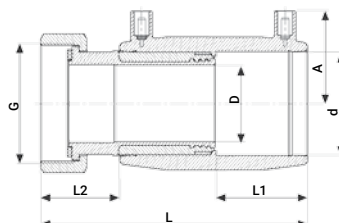

Product Code	Size d x G	L	L1	L2	D	A	UC	W
494104020007	20 x 3/4"	106	37	30	14	34	200	150
494104025007	25 x 3/4"	112	40	30	14	37	140	150
494104025010	25 x 1"	115	40	33	19	37	140	200
494104032007	32 x 3/4"	100	39	20	14	42	100	164
494104032010	32 x 1"	124	42	36	19	42	100	260
494104032013	32 x 1 1/4"	124	42	36	23	42	78	310
494104040010	40 x 1"	115	44	25	19	47	52	278
494104040013	40 x 1 1/4"	113	44	23	23	47	52	320
494104040015	40 x 1 1/2"	135	47	38	29	45	52	444
494104050010	50 x 1"	136	49	36	19	52	32	700
494104050013	50 x 1"	120	49	23	23	52	32	371
494104050015	50 x 1"	123	49	25	29	52	32	484
494104050020	50 x 2"	141	49	41	38	52	32	709
494104063020	63 x 2"	161	57	44	38	57	28	770
494104063025	63 x 2 1/2"	166	57	49	48	57	20	1154

* May be converted into male free nut by addition of a threaded nipple.

* Se puede convertir en la tuerca loca macho mediante la adición de un niple roscado.

Female Free Nut Transition Elbow 90°*

494504

Codo de Transición de 90° Tuerca Libre, Hembra

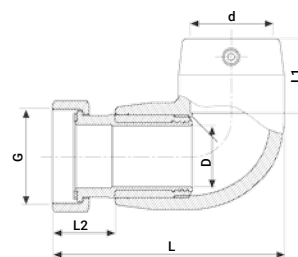

Product Code	Size d x G	L	L1	L2	D	A	UC	W
494504020007	20 x 3/4"	96	35	30	14	38	140	164
494504025007	25 x 3/4"	96	37	30	14	38	140	164
494504025010	25 x 1"	99	37	33	19	38	105	164
494504032010	32 x 1"	119	40	36	19	43	70	164
494504032013	32 x 1.1/4"	119	40	36	23	43	70	324
494504040015	40 x 1.1/2"	132	44	40	29	47	48	490
494504050020	50 x 2"	149	48	41	38	52	30	779
494504063020	63 x 2"	175	57	44	41	59	16	1024
494504063025	63 x 2.1/2"	180	57	49	48	59	16	1245

* May be converted into male free nut by addition of a threaded nipple.

* Se puede convertir en la tuerca loca macho mediante la adición de un niple roscado.

Female Free Nut Transition Elbow 45°*

494604

Codo de Transición de 45° Tuerca Libre, Hembra

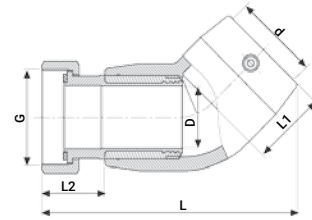

Product Code	Size d x G	L	L1	L2	D	A	UC	W
494604032010	32 x 1"	131	39	36	19	43	70	164
494604032013	32 x 1.1/4"	129	39	34	23	47	56	400
494604040015	40 x 1.1/2"	146	44	38	29	47	48	469
494604050020	50 x 2"	166	49	41	38	51	30	740
494604063020	63 x 2"	189	57	41	38	59	24	950
494604063025	63 x 2.1/2"	197	57	44	48	59	16	1184

* May be converted into male free nut by addition of a threaded nipple.

* Se puede convertir en la tuerca loca macho mediante la adición de un niple roscado.

Female Union Free Nut Transition Tee

494404

Enlace T, PE/Latón, Tuerca Libre, Hembra

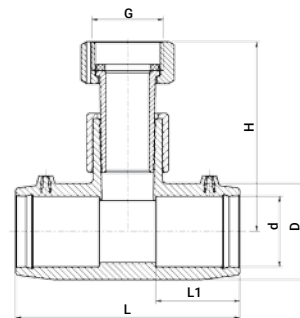

Product Code	Size d x G	L	L1	D	H	A	UC	W
494404032010	32 x 1"	104	39	44	88	43	50	320

PE Male Transition Coupler

497104

Enlace de Transición PE Macho

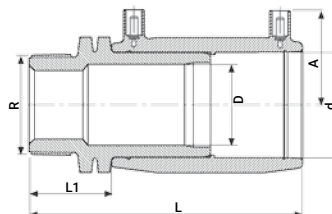

Product Code	Size d x R	D	L	L1	UC	W
497104020005	20 x 1/2"	14	97	21	200	129
497104025007	25 x 3/4"	18	113	31	200	61
497104032010	32 x 1"	24	123	35	200	92
497104040010	40 x 1"	30	134	37	128	146
497104040013	40 x 1.1/4"	30	137	40	144	152
497104040015	40 x 1.1/2"	30	137	40	128	159
497104050015	50 x 1.1/2"	38	141	40	96	238
497104063015	63 x 1.1/2"	48	161	44	40	371
497104063020	63 x 2"	48	165	48	40	450

PE Male Transition Elbow 90°

497504

Codo de Transición PE de 90° Macho

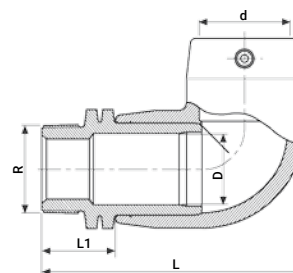

Product Code	Size d x R	A	D	L	L1	UC	W
497504020005	20 x 1/2"	38	14	87	35	200	458
497504025007	25 x 3/4"	38	18	97	37	200	77
497504032010	32 x 1"	43	24	118	40	96	120
497504040010	40 x 1"	47	30	129	44	48	187
497504040013	40 x 1.1/4"	47	30	132	44	48	202
497504040015	40 x 1.1/2"	47	30	132	44	48	250
497504050015	50 x 1.1/2"	52	38	148	48	48	296
497504063015	63 x 1.1/2"	59	48	175	57	24	458
497504063020	63 x 2"	59	48	179	57	24	471

PE Male Transition Elbow 45°

497604

Codo de Transición PE de 45° Macho

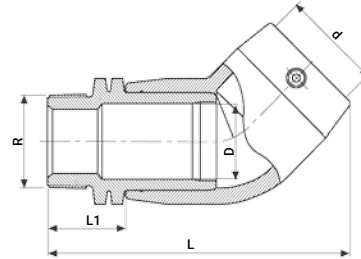

Product Code	Size d x R	D	L	L1	UC	W
497604032010	32 x 1"	24	141	39	96	150
497604040010	40 x 1"	30	145	42	96	175
497604040013	40 x 1.1/4"	30	148	42	96	185
497604040015	40 x 1.1/2"	30	148	42	96	185
497604050015	50 x 1.1/2"	38	165	49	48	271
497604063015	63 x 1.1/2"	48	192	57	24	465
497604063020	63 x 2"	48	196	57	24	470

PE Cast Iron Flange Transition Coupler

497704

Enlace de Transición Bridado - PE Hierro Fundido

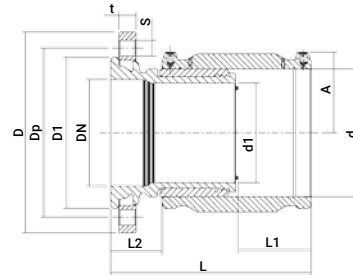

Product Code	Size d x DN	A	L	L1	L2	D1	d1	D	Dp	s	t	No. of holes	UC	W
497704063	63 x 50	57	217	57	100	104	43	165	125	18	20	4	4	4200
497704090	90 x 80	70	216	73	68	139	67	200	160	18	20	8	4	5940
497704110	110 x 100	79	223	80	61	159	84	220	180	18	22	8	4	7280
497704125	125 x 100	87	235	85	62	159	98	220	180	18	22	8	4	7759
497704160	160 x 150	105	268	93	73	215	125	285	240	22	24	8	1	13400
497704180	180 x 150	116	284	105	72	215	140	285	240	22	24	8	1	15246
497704225	225 x 200	138	314	119	74	270	176	340	295	22	26	8	1	23919

PE Cast Iron Spigot Transition Coupler

495704

Enlace de Transición Espiga - PE Hierro Fundido

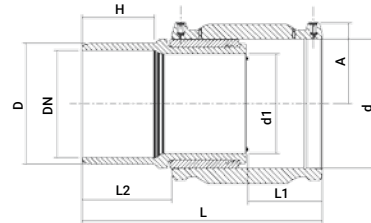

Product Code	Size d x DN	A	L	L1	L2	D	d1	H	UC	W
495704090080	90 x 80	69	254	73	106	98	67	94	8	2874
495704110100	110 x 100	79	275	80	112	118	84	96	8	4170
495704125100	125 x 100	87	280	85	107	118	98	91	8	4569
495704160150	160 x 150	104	322	97	124	170	125	102	8	8105
495704180150	180 x 150	114	339	104	127	170	140	103	8	10121
495704225200	225 x 200	140	372	118	132	222	176	109	8	12284

Full Face Flange

490209

Brida de Cara Plana

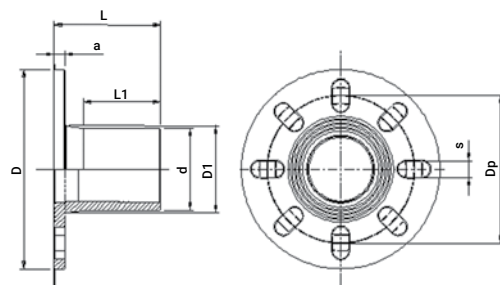

Product Code	Size d	L	L1	D	D1	a	Dp	s	UC	W
490209090	90	118	86	220	98	12	163	20	18	995
490209110	110	—	—	—	—	—	—	—	—	—
490209125	125	—	—	—	—	—	—	—	3	600
490209160	160	—	—	—	—	—	—	—	2	1750
490209180	180	—	—	—	—	—	—	—	2	1610
490209225	225	—	—	—	—	—	—	—	—	—

Stub Flange

490207

Adaptador de Brida

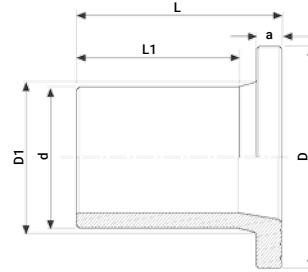

Product Code	Size d	L	L1	a	D	D1	UC	W
490207020	20	85	45	7	45	26	160	26
490207025	25	85	40	9	58	32	160	42
490207032	32	85	60	10	68	40	160	57
490207040	40	85	60	11	78	50	160	84
490207050	50	104	75	12	88	61	144	132
490207063	63	120	87	14	102	75	60	220
490207075	75	130	92	16	122	89	48	322
490207090	90	140	96	17	138	105	32	475
490207110	110	160	110	18	158	125	20	747
490207125	125	182	132	25	158	132	16	945
490207140	140	180	130	25	188	155	12	1245
490207160	160	180	130	25	212	175	8	1600
490207180	180	198	140	30	212	187	8	1990
490207200	200	200	135	32	268	232	4	3100
490207225	225	200	135	32	268	235	4	3360
490207250	250	215	145	35	320	285	3	5080
490207280	280	228	160	35	320	291	2	5605
490207315	315	238	160	35	370	335	2	7470
490207355	355	255	175	40	430	373	1	10475
490207400	400	286	195	45	482	427	1	14970

Flange Backing Ring

09903

Brida Revestida

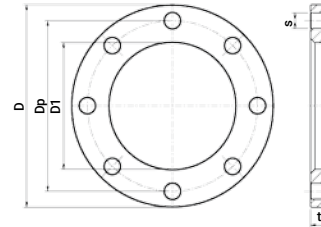

Product Code	Flange Type	Flange	D	Dp	D1	s	t	No. of Holes	UC	W
09903020	ISO/DIN PN 10/16	20 x 1/2"	95	65	28	14	12	4	200	240
09903025	ISO/DIN PN 10/16	25 x 3/4"	105	75	34	14	14	4	180	300
09903032	ISO/DIN PN 10/16	32 x 1"	115	85	42	14	16	4	150	490
09903040	ISO/DIN PN 10/16	40 x 1.1/4"	140	100	51	18	18	4	120	685
09903050	ISO/DIN PN 10/16	50 x 1.1/2"	150	110	62	18	18	4	100	812
09903063	ISO/DIN PN 10/16	63 x 2"	165	125	78	18	18	4	20	1110
09903075	ISO/DIN PN 10/16	75 x 2.1/2"	185	145	92	18	20	4	—	1160
09902095	ISO/DIN PN 10/16	90 x 2.1/2"	185	145	102	18	20	8	—	—
09903090	ISO/DIN PN 10/16	90 x 3"	200	160	108	18	20	8	100	1400
09903110	ISO/DIN PN 10/16	110 x 4"	220	180	128	18	22	8	100	1570
09903125	ISO/DIN PN 10/16	125 x 4"	220	180	135	18	22	8	—	1470
09903140	ISO/DIN PN 10/16	140 x 5"	250	210	158	18	22	8	30	1930
09903160	ISO/DIN PN 10/16	160 x 6"	285	240	178	22	24	8	12	2700
09903180	ISO/DIN PN 10/16	180 x 6"	285	240	188	22	24	8	10	2150
09903200	ISO/DIN PN 10	200 x 8"	340	295	235	22	24	8	4	3600
09903225	ISO/DIN PN 10	225 x 8"	340	295	238	22	24	8	8	3510
09903250	ISO/DIN PN 10	250 x 10"	395	350	288	22	26	12	8	5200
09901250	BS 10 Table D	250 x 10" BS	395	355	288	22	26	8	—	—
09903280	ISO/DIN PN 10	280 x 10"	395	350	294	22	26	12	4	5500
09901280	BS 10 Table D	280 x 10" BS	395	355	294	22	26	8	—	—
09903315	ISO/DIN PN 10	315 x 12"	445	400	338	22	26	12	3	8350
09901315	BS 10 Table D	315 x 12" BS	445	406	338	22	26	12	—	—
09901355	BS 10 Table D	355 x 14" BS	520	470	376	26	12	16	—	—

Wastewater System, We Make the Connection

Polyethylene offers the ideal cost-effective and technically superior alternative to other materials, requiring minimal effort to install, reducing the number of connections required and increasing the system lifespan.

The Plasson System constitutes an excellent investment for both public wastewater infrastructures and private wastewater systems

The Plasson wastewater system offers a strong, long-life and is resistant to axial loads through its special versatile products that can be completely fused after being laid.



Systemas de Aguas Residuales, Hacemos la Conexión

En comparación con otros materiales, el polietileno constituye la alternativa ideal en términos de costo-beneficio y superioridad técnica, ya que requiere un mínimo esfuerzo de instalación, con menos conexiones, y asegura una larga vida útil. El sistema de Plasson es una inversión excelente, tanto para las infraestructuras públicas de aguas residuales como para los sistemas privados.

Los sistemas de Plasson para aguas residuales son muy duraderos y resistentes a las cargas axiales, gracias a la versatilidad de sus productos que pueden fusionarse completamente después de la instalación.

Wastewater Adjustable Saddle

475804

Ramal Para Aguas Residuales

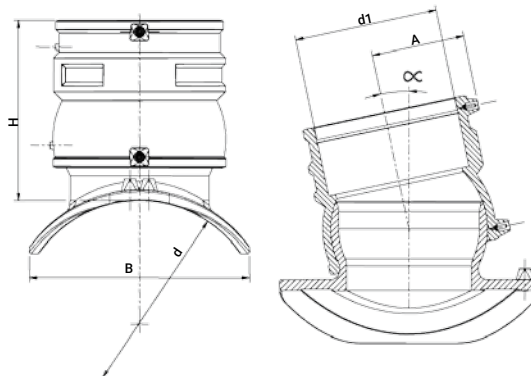

Product Code	Size d x d1	B	H	A	L	UC	W
475804200160	200 x 160	208	202	105	290	4	2050
475804250160	225-250 x 160	225	202	105	290	4	2060
475804315160	280-315 x 160	247	202	105	290	4	2070
475804560160	355-560 x 160	263	202	105	290	4	2080
475804710160	560-710 x 160	277	202	105	290	4	2080

* See dedicated tools on page 164 | * Ver herramientas necesarias en pag. 164

Wastewater Saddle 45° - Inlet 110

4758A4

Ramal 45° de Salida Para Aguas Residuales

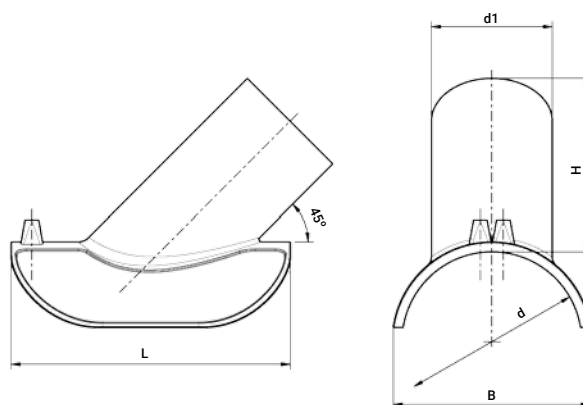

Product Code	Size d x d1	L	B	H	UC	W
4758A4160110	160-200 x 110	255	182	158	10	685
4758A4250110	225-315 x 110	255	221	158	10	710

* See dedicated tools on page 164 | * Ver herramientas necesarias en pag. 164

Wastewater Saddle PVC/PP Adaptor Inlet

4758V4

Collarín lightfit de transición para aguas residuales de PE A PP/PVC

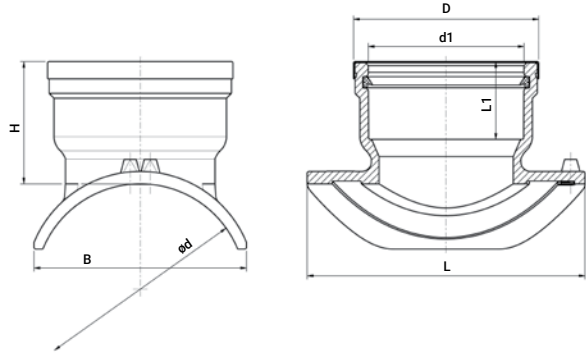

Product Code	Size d x d1	B	H	L	L1	D	UC	W
4758V4200160	200 x 160	208	125	290	80	190	6	1660
4758V4250160	225-250 x 160	225	125	290	80	190	6	1309
4758V4315160	280-315 x 160	245	125	290	80	190	6	1326
4758V4560160	355-560 x 160	263	125	290	80	190	6	1430
4758V4710160	560-710 x 160	277	125	290	80	190	6	1527

* See dedicated tools on page 164 | * Ver herramientas necesarias en pag. 164

Wastewater Saddle Spigot Inlet

4758S4

Titulo

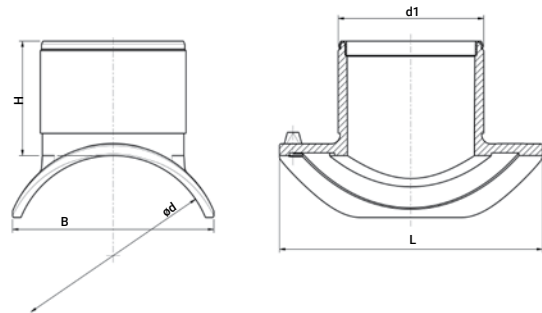

Product Code	Size d x d1	B	H	L	UC	W
4758S4200160	200 x 160	208	125	290	6	1091
4758S4250160	225 - 250 x 160	225	125	290	6	1239
4758S4315160	280 - 315 x 160	247	125	290	6	1260
4758S4560160	355 - 560 x 160	263	125	290	6	1300
4758S4710160	560 - 710 x 160	277	125	290	6	1310

* See dedicated tools on page 164 | * Ver herramientas necesarias en pag. 164

Wastewater Adjustable Elbow One Sided

4747D4

Codo Ajustable Para Aguas Residuales

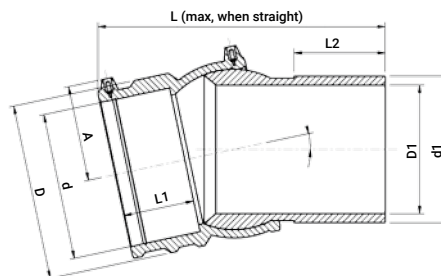

Product Code	Size d	SDR	D	D1	L	L1	L2	A	UC	W
4747D4160	160	17	193	141	298	78	98	105	6	3030

Wastewater Manhole Adaptor

37020/477207*

Adaptador Para Pozo de Aguas Residuales

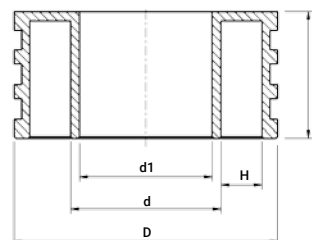

Product Code	Size d	L	d1	D	H	UC	W
37020110	110	135	97	216	37	—	1650
37020125	125	135	111	235	39	—	1800
37020140	140	135	123	254	39	—	1950
477207160	160*	135	141	280	39	6	2524
37020180	180	135	157	335	66	4	3550
37020200	200	135	176	355	56	2	3660
477207225	225*	135	198	355	44	2	3902
37020250	250	135	220	400	54	2	3740
477207280	280*	135	247	400	39	2	5027
37020315	315	135	278	450	46	2	5130
37020355	355	135	313	500	50	2	6480
37020400	400	135	353	560	59	1	8260
37020450	450	135	397	592	50	—	22350
37020500	500	135	441	651	54	—	23600
37020560	560	135	494	705	51	—	34500
37020630	630	135	555	773	50	—	47370

Wastewater PE to PVC Adaptor

4701V4

Adaptador Para PE A PVC

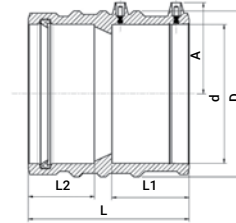

Product Code	Size d	L	L1	L2	D	A	UC	W
4701V4160	160	187	90	77	193	106	1546	6

Wastewater Adjustable Elbow PE to PVC

4747V4

Codo Ajustable de Transicion de PE a PVC

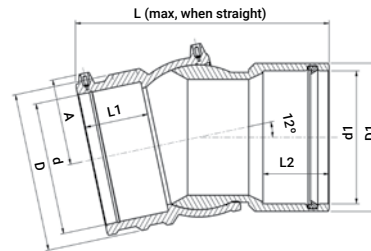

Product Code	Size d x d1	D	D1	L	L1	L2	A	UC	W
4747V4160	160 x 160	193	180	253	78	80	105	6	2140

Wastewater Elbow 45°

470604

Codo 45° Para Aguas Residuales

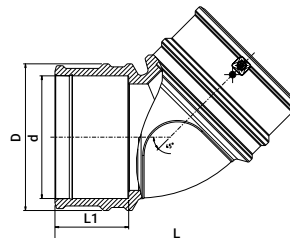

Product Code	Size d	L	L1	D	A	UC	W
470604160	160	325	98	193	106	—	1976

Wastewater Elbow 30°

473304

Codo 30° Para Aguas Residuales

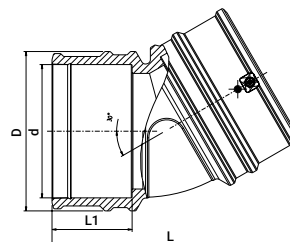

Product Code	Size d	L	L1	D	A	UC	W
473304160	160	302	98	193	106	—	1798

Wastewater Elbow 15°

473704

Codo 15° Para Aguas Residuales

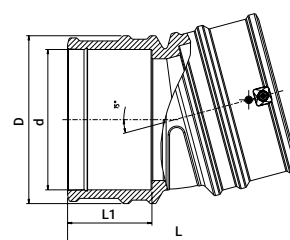

Product Code	Size d	L	L1	D	A	UC	W
473704160	160	267	98	193	106	—	1728

Technical Specifications

Technical Specifications for Plasson ElectroFusion Fittings

Fitting Pressure Rating and Pipe Compatibility

Plasson Fittings are weldable to PE80, PE100, PE100-RC and PE-X pipes (most fittings)*.

Check that the pipe SDR is compatible with the Plasson fittings.

The range of compatible pipe SDR's for each specific fitting is defined on the fitting barcode label.

For questions regarding pipe SDR compatibility refer to Plasson literature or contact your local Plasson representative.

* Please consult your Plasson representative

The following is a general guideline for Plasson EF product pipe SDR compatibility (in any case of discrepancy between the figure below and the figure on the barcode label, always refer to the barcode data).

Plasson's ElectroFusion Fittings:

- PN 16 (Water)
- PE100 SDR11 (Gas)
- Up to 75mm (inclusive) are Weldable to Pipes SDR ≤ 11
- Elbows and Tees of main diameter 40mm-75mm ≤ 17
- 90mm & Up are Weldable to Pipes SDR ≤ 17
- 63-75mm Tapping Saddles and Valves are suitable for SDR11

Note: for tapping SDR ≤ 11 pipes (size 63 and up), please consult your Plasson representative.

LightFit:

- PN 10 (Water)
- PE100 SDR17 (Gas)
- 40mm - 75mm are Weldable to Pipes SDR ≤ 17
- 90mm are Weldable to Pipes SDR ≤ 26
- 110mm - 800mm are Weldable to Pipes SDR ≤ 33

Wastewater Saddle

- PN 0.5 (Water)
- 200mm & Up are Weldable to Pipes SDR ≤ 26

Wastewater Adjustable Elbow

- PN 0.5 (Water)
- 160mm is Weldable to Pipes SDR ≤ 17

Measure the pipe external diameter toward the pipe end using a Pi tape. The pipe external diameter must be within the tolerances defined in International standards such as ISO 4437-2, AS/NZS, 4130, EN 1555-2 and EN 12201-2.

Material

All Plasson ElectroFusion fittings are produced from material class PE100 which conform to international standards for potable water and natural or suitable manufactured gas systems.

Standards

Plasson ElectroFusion fittings are designed, tested and quality controlled according to Plasson's internal standards. These standards are based on the following international standards:

- EN 1555
- EN 12201
- NF 136
- AS/NZS 4129
- WIS 4-32-14
- WIS 4-32-15

Quality

Plasson has incorporated a quality assurance system in accordance with ISO 9001. Operating approval according to ISO 9001 was granted to Plasson by the Israeli Standard Institute. Operating according to the ISO 9001 quality assurance system imposes stringent standards of control throughout the manufacturing processes.

Abbreviations used on the product description pages of this catalog:

A, A1	Height of shroud from centerline	L, L1, L2	Length
d, d1	Nominal diameter of fitting or outlet	c	Number of bolt holes in flanges
D, D1	Diameter	s	Diameter of bolt holes in flanges
DN	Nominal bore corresponding approximately to the inside diameter of the pipe	t	Thickness of metal flange
Dp	Pitch circle diameter of bolt holes in flanges	W	Weight in grams
G, R, Rp	Threaded outlet diameter	UC	Units per carton
H	Height	Fusion and cooling time are specified on the individual product.	

Whereas the products shown in this catalogue illustrate and describe the current state of their development, Plasson reserves the right at all times to make such technical alterations as it shall see fit to its products. Although every care has been taken in the preparation of the information, specifications and other data included in this catalogue, we cannot rule out inadvertent errors or omissions. Purchasers should take into account possible deviations or variations which will not substantially diminish the functionality or performance of the products, and, in many cases, are designed to improve the same.

Plasson® is the Registered Trademark of Plasson Ltd. or Plasson Maagan Michael Industries Ltd. Plasson's products are protected by patents, trademark, design and copyright laws.

Especificaciones técnicas para los accesorios ElectroFusion de Plasson

Presiones nominales y compatibilidad con la tubería

Los accesorios ElectroFusion de PLASSON se pueden soldar a tuberías de materiales PE80, PE100, PE100-RC, PE-X (la mayoría de los accesorios)*

Por favor revise que el SDR de la tubería es compatible con el rango declarado en el código de barras del accesorio Plasson. Cada accesorio Plasson contiene esta información.

Nota: para obtener más información sobre SDR de tuberías vea la información del fabricante de la tubería a soldar y literatura de Plasson. Ante cualquier duda consulte a su representante de Plasson

A continuación una guía general sobre la compatibilidad de accesorios Plasson según el SDR del tubo a electrofusionar. (En caso de existir alguna discrepancia por favor proceda según indica la calcomanía del accesorio que contiene el código de barras).

Presiones nominales

Las presiones nominales de todos los accesorios ElectroFusion de PLASSON son las siguientes:

- PN 16 (Agua)
- MOP10 (Gas)

Accesorios de ElectroFusión de Plasson

- Hasta 75mm (inclusive), soldables en tuberías SDR ≤ 11
- Codos y Tes en diámetros 40mm – 75mm ≤ 17
- De 90mm en adelante soldables en tuberías SDR ≤ 11
- De 63-75mm Tomas en carga y Válvulas soldables en tuberías SDR 11

NOTA: Para tuberías SDR ≤ 11 (diámetro desde 63mm hacia arriba) consulte a su representante de Plasson.

LightFit:

- PN10 (Agua)
- PE100 SDR 17 (GAS)
- 40mm - 75mm soldables en tuberías SDR ≤ 17
- 90mm soldables en tuberías SDR ≤ 26
- 110mm - 800mm soldables en tuberías SDR ≤ 33

Ramales de ElectroFusión Plasson para aguas residuales

- PN 0.5 (Agua)
- De 200mm en adelante en tuberías SDR ≤ 26

Codos ajustables de ElectroFusión para aguas residuales

- PN 0.5 (Agua)
- De 160mm en adelante en tuberías SDR ≤ 17

Para medir el diámetro externo de una tubería utilice una cinta PI. El diámetro externo debe estar contemplado dentro de las tolerancias estipuladas en las normas internacionales ISO 4437-2, AS/NZS.

Material

Todos los accesorios ElectroFusión de Plasson se fabrican con material de clase PE100, de conformidad con las normas internacionales para sistemas de agua potable y gas natural o procesado. Accesorios de PE80, disponibles a petición del cliente.

Normativa

El diseño, las pruebas y el control de calidad de los accesorios ElectroFusion de Plasson se llevan a cabo de acuerdo con las normas internas de Plasson, basadas en las siguientes normativas internacionales:

- EN 1555
- EN 12201
- NF 136
- AS/NZS 4129
- WIS 4-32-14
- WIS 4-32-15

Aseguramiento de Calidad

Plasson utiliza el sistema de aseguramiento de calidad conforme a la normativa ISO 9001. La certificación de la empresa de acuerdo con ISO 9001 le fue otorgada a Plasson por el Instituto Israelí de Normas Industriales. La operación conforme a la normativa de aseguramiento de calidad ISO 9001 impone estrictos procedimientos de control durante todos los procesos de fabricación.

Abreviaturas utilizadas en la descripción de productos de este catálogo:

A, A1	Altura desde la línea central a la cubierta del resistor	L, L1, L2	Longitud
d, d1	Diámetro nominal del accesorio o salida	c	Número de orificios en las bridas
D, D1	Diámetro	s	Diámetro de los orificios p/tornillos en las bridas
DN	Diámetro nominal interno, correspondiente aproximadamente al diámetro interno del tubo	t	Grosor de la brida metálica
Dp	Diámetro de los orificios en las bridas	W	Peso en gramos
G, R, Rp	Diámetro de la salida roscada	UC	Cantidad por caja de cartón
H	Altura	Los tiempos de soldadura y enfriamiento se indican en cada producto.	

Si bien en este catálogo se ilustran y describen los productos en el estado actual de su desarrollo, PLASSON se reserva el derecho de introducir en cualquier momento las modificaciones técnicas que considere convenientes.

La preparación de la información, especificaciones y otros datos se ha hecho con el mayor cuidado, no obstante lo cual no podemos asegurar que estén libres de errores u omisiones involuntarios. El cliente debe tener en cuenta la posibilidad de desviaciones o variaciones que no afectarán significativamente el funcionamiento o rendimiento de los productos y que, en muchos casos, están destinadas a mejorarlos.

Plasson™ es la marca registrada de Plasson Ltd. o Plasson Maagan Michael Industries Ltd.

Los productos de Plasson están protegidos por derechos de patente, marcas comerciales, diseño y leyes de copyright.

Controllers

The Smart Fuse System - Plasson ElectroFusion

Plasson offers quality tools and control boxes ensuring easy installation and safe, dependable connections.

All Plasson products combine to form the latest state-of-the art high performance pipe joining solution.

Plasson fittings include an automatic recognition system which is part of the complete Smart Fuse System.

The entire ElectroFusion process is executed and fully monitored by the computerized control box.

Plasson ElectroFusion fittings can be used with Plasson's computerized Smart Fuse System control box or with standard barcode systems.

Each Plasson ElectroFusion fitting comes complete with a barcode.

Plasson provides superior products and unmatched service based on over 50 years in the field.

For our complete tooling range please ask your local Plasson representative.

PLASSON Control Box product family includes the following features:

- Automatic (Smart Fuse System) welding for PLASSON ElectroFusion couplings up to 12 IPS
- Ergonomic design
- Fusion process supervision system
- Fully monitored welding process
- 4 x 20 alphanumeric character display with backlight and adjustable contrast
- Easy end user oriented data input
- Highly flexible welding cable
- Reduced service expense by software controlled calibration
- Easy data transfer to PC printer or portable memory box
- All controllers are equipped with bluetooth feature

PolyCode (USB + Bluetooth)

29143.0308S324

Control box for welding of small fittings

For all EF fittings up to 160mm*
mounted in plastic suitcase

Technical specifications

Output current	75 A (54 A peak current)
Welding voltage	8-48 V
Power supply	230 V (190-300 V) 16 A
Weight	11 kg
Dimensions	47x18x37 cm
Welding cable length	3 m
Data recording	1000 welding cycles, downloadable by USB memory stick
Display	4 lines alphanumeric display, available in 26 languages



Welding data input

Plasson "SmartFuse" automatic welding data input
Barcode reading (including temperature compensation)
Manual input of barcode digits

* At long welding cycles, cool down time equal to the welding time is required

PolyControl Plus (USB + Bluetooth) V2.0

29143.F0318V112

High power control box

Incorporates fan cooled electronic voltage converter
For continuous welding cycles of large fittings (no need for cool down)
For all EF fittings
Compact and lightweight aluminum casing

Technical specifications

Output current	85 A (110 A peak)
Welding voltage	8-48 V
Power supply	230 V (190-300 V) 16 A
Weight	15.5 kg
Dimensions	20x32x44 cm
Welding cable length	3 m
Data recording	1000 welding cycles, downloadable by USB memory stick
Display	4 lines alphanumeric display, available in 26 languages
Packaging	Flight case, size 50x42x39 cm, weight 8 kg



Welding data input

Plasson "SmartFuse" automatic welding data input
Barcode reading (including temperature compensation)
Manual input of barcode digits
Manual input of welding voltage and time

Polymatic Plus (USB + Bluetooth)

29143.0307.103

Universal control box

Incorporates fan cooled electronic voltage converter
 For continuous welding cycles of large fittings (no need for cool down)
 For all EF fittings
 Compact and lightweight aluminum casing



Technical specifications

Output current	75 A (110 A peak)
Welding voltage	8-48 V
Power supply	230 V (190-300 V) 16 A
Weight	18 kg
Dimensions	45x33x38 cm
Welding cable length	Detachable 5 m
Data recording	1000 welding cycles, downloadable by USB memory stick
Display	4 lines alphanumeric display, available in 26 languages
Packaging	Plastic case, size 47x44x38 cm, weight 4 kg

Welding data input

Plasson "SmartFuse" automatic welding data input
 Barcode reading (including temprature compansation)
 Manual input of barcode digits
 Manual input of welding voltage and time

* At long welding cycles, cool down time equal to the welding time is required

Tiny Data MF (USB + Bluetooth)

29143.0308T108

Compact control box

For all EF fittings up to 400mm*
 Compact steel casing

Technical specifications

Output current	56 A (110 A peak current)
Welding voltage	8-48 V
Power supply	230 V (190-300 V) 16 A
Weight	16.5 kg
Dimensions	33x28x29 cm
Welding cable length	4 m
Data recording	1000 welding cycles, downloadable by USB memory stick
Display	4 lines alphanumeric display, available in 26 languages
Packaging	Wooden box, size 39x32x34 cm, weight 5.5 kg



Welding data input

Plasson "SmartFuse" automatic welding data input
 Barcode reading (including temprature compensation)
 Manual input of barcode digits
 Manual input of welding voltage and time

* At long welding cycles , cool down time equal to the welding time is required

Monomatic Data (USB + Bluetooth)

29143.0307.000

Dedicated controller for "SmartFuse" system

For Plasson "SmartFuse" fittings only, up to 400mm*
Durable steel and plastic casing

Technical specifications

Output current	56 A (110 A peak current)
Welding voltage	40 V
Power supply	230 V (190-300 V) 16 A, 50/60 Hz (40-70 Hz)
Weight	18 kg
Dimensions	45x33x38 cm
Welding cable length	Detachable 5 m
Data recording	500 welding cycles, downloadable by USB memory stick
Display	4 lines alphanumeric display, available in 26 languages
Packaging	Plastic case, size 47x44x38 cm, weight 4 kg



Welding data input

Plasson "SmartFuse" automatic reading

* At long welding cycles , cool down time equal to the welding time is required

ESPAÑOL

El sistema inteligente ElectroFusion de Plasson

Plasson ofrece herramientas y soldadoras automáticas de electrofusión de la más alta calidad, para facilitar la instalación y asegurar conexiones fiables.

Todos los productos de Plasson se combinan para brindar la solución más avanzada y eficiente de conexión de tuberías. Los accesorios de Plasson contienen un sistema de reconocimiento automático que forma parte de todo el sistema inteligente. La soldadora automática ejecuta y supervisa todo el proceso de electrofusión.

Los accesorios ElectroFusion de Plasson pueden utilizarse con la soldadora automática de Plasson, controlada por computadora, o con los sistemas estándar de código de barras.

Cada accesorio ("fitting") ElectroFusion de Plasson se entrega completo, con su propio código de barras.

Plasson se enorgullece de suministrar productos de excelente calidad y un servicio incomparable, respaldado por una experiencia de más de 50 años en el terreno.

Para obtener información sobre toda la línea de herramientas, consulte a su representante local de Plasson.

Soldadoras

La línea de soldadoras automáticas de PLASSON tiene las siguientes características:

- Soldadura automática para los enlaces ("cuplas") ElectroFusion de PLASSON hasta 12 IPS
- Diseño ergonómico
- Sistema de supervisión del proceso de electrofusión
- Soldadura totalmente monitorizada
- Pantalla de 4 x 20 caracteres alfanuméricos con iluminación de fondo y contraste ajustable
- Entrada de datos fácil y cómoda para el usuario
- Cable de soldadura altamente flexible
- Ahorro en costos de servicio gracias a la calibración controlada por software
- Facilidad en la transferencia de datos a PC, impresora o dispositivo de memoria portátil

PolyCode (USB + Bluetooth)

29143.0308S324

Entrada parámetros de soldadura

Máquina de Electrofusión Universal para accesorios hasta 160 mm

La máquina de electrofusión tipo PolyCode (USB) incorpora los siguientes procedimientos para incorporar los parámetros de soldadura:

Soldadura modo código de barras ISO/TR 13950, TIPO 2/5i, 24 dígitos)

El código de barras incorporado en la mayoría de los accesorios electrosoldables del mercado contiene todos los datos necesarios para la realización de la soldadura por electrofusión. Después de leer el código de barras con el dispositivo correcto, el proceso de recogida de datos es realizado automáticamente por la máquina de electrofusión. El código de barras contiene principalmente la siguiente información: Fabricante, tipo, diámetro, voltaje de fusión, tiempo de fusión (con la compensación de Temperatura, si es necesario), resistencia y tolerancia de la resistencia.



Soldadura modo automático SmartFuse

Mediante la lectura de la resistencia de referencia colocada en el pin de los accesorios electrosoldables SmartFuse, la unidad de control aplica automáticamente los datos de soldadura del accesorio.

Entrada manual del código de barras (los dígitos)

Si el código de barras del accesorio o el dispositivo de lectura tienen algún defecto, es posible entrar los números del código de barras del accesorio (si son visibles) manual mente en la máquina de electrofusión.

Especificaciones técnicas

Voltaje salida (soldadura)	8 - 48 AC
Rango Voltaje (nominal)	230 V (190-300 V) 16 A
Peso de transporte	11 Kilos
Medidas de embalaje	47x18x37 cm
Longitud cable soldadura	3 metros
Ingreso y lectura de datos de soldadura	"Smart Fuse" de Plasson que incluye compensación de temperatura, lectura de código barras con scanner, ingreso manual del código de barras (los dígitos)
Memoria de datos	Hasta 1,000 ciclos. Contiene puerto USB para bajar los datos registrados
Pantalla	4 líneas alfanuméricas en 26 idiomas

PolyControl Plus (USB + Bluetooth) V2.0

29143.F0318V112

Soldadora universal

Rango de aplicación

Las soldadoras de electrofusión del tipo PolyControl Plus (USB) V2.0 están exclusivamente destinadas a la soldadura de tubos termoplásticos (o sea de PE-HD, PE80, PE100 o PP) con accesorios de menos de 48V en su voltaje de entrada.

Estos dispositivos cumplen las especificaciones de las normativas DVS 2208-1 e ISO-12176-2, de las cuales derivan las normas aplicables a los equipos de electrofusión.



Rango de dimensiones

El rango de dimensiones de los accesorios para los cuales puede utilizarse una soldadora depende en primer lugar del consumo de energía de los accesorios. Dado que el consumo no es uniforme para todos los fabricantes, no es posible generalizar, y en caso de duda, es preciso examinar cada accesorio por separado. Para las soldadoras del tipo PolyControl Plus (USB) V2.0, y suponiendo que todas las operaciones de soldadura se realizan en secuencia, es decir que la soldadora tiene tiempo para enfriarse mientras se prepara el accesorio siguiente, se podría emitir la siguiente declaración general:

Utilizable sin limitaciones para todas las dimensiones de accesorios con hasta 85 A de consumo permanente de corriente. Todo lo dicho se refiere al trabajo con una temperatura ambiente de 20°C.

Nota: Si el ventilador de la parte trasera de la soldadora no está funcionando, el rango de tamaños se reduce a lo siguiente: hasta 250mm sin limitaciones, de 280 a 400mm con periodos de enfriamiento. No debe utilizarse la soldadora sin el ventilador para tamaños de más de 400mm a fin de evitar que el dispositivo resulte dañado.

Especificaciones técnicas

3F0218V112

PolyControl Plus (USB) V2.0

General

Tensión de salida	8 a 48 DC [V]
Registro de datos	Sí
Potencia (60% del tiempo ON) conformidad con ISO 12176-2	3600 W (100 A)
Rango de temperaturas	-10 a +50 [°C]
Protección	IP54
Clase de aplicación	1
Conformidad con	CE
Clase ISO 12176-2 - clasificación	P ₂ 4 U S ₁ V AK D X

Entrada de parámetros de soldadura

Código de barras con lector (escaneo opcional)	Sí
SmartFuse/(FUSAMATIC)	Sí
Entrada manual del código del accesorio	Sí
Entrada manual de parámetros de soldadura	Sí, U _{OUT} : 8 a 48 V, tWELD: 0 a 9999 s
Entrada manual de parámetros de soldadura	No, U _{OUT} : 48V (prefijado), tWELD: 0 a 9999 s

Entrada/Red eléctrica

Tensión	AC
Tensión nominal	230 [V]
Rango de tensión nominal (tolerancia)	185 a 300 [V]
Frecuencia nominal	50 [Hz]
Rango de frecuencia nominal (Tolerancia)	40 a 70 [Hz]
Factor de potencia cos ϕ	1 - PFC (EN 61000-3-3)
Corriente nominal	16 [A]
Consumo eléctrico	3600 [VA]
Longitud del cable	4.5 [m]
Tipo de enchufe	Euro plug

Especificaciones técnicas

3F0218V112

PolyControl Plus (USB) V2.0

Salida

Tensión	DC
Tensión de salida	8 a 48 [V]
Corriente de salida (max.)	110 [A]
Corriente de salida (t → ∞)	85 [A]
Corriente de salida (min.)	2 [A]
Ajuste de energía	Compensación de temperatura, Compensación de inductividad
Longitud del cable de soldadura	3 [m]
Montaje del cable de soldadura	Fijo
Terminales de soldadura	4.0 [mm] (opcional 4.7 [mm])

Funciones de monitorización

Tensión de entrada	Corriente, Frecuencia
Tensión de salida	Corriente, Resistencia, Contacto, Cortocircuito
Otro	Sistema, Temperatura de trabajo, Servicio
Mensajes de error	Texto, Señal acústica

Caja

Material	Aluminio de fundición
Pantalla	4 x 20 caracteres (alfanuméricos), iluminación de fondo
Peso del producto (sin cable de soldadura)	11 [kg]
Peso del producto (cable de soldadura incluido)	15.5 [kg]
Dimensiones Long x An x Alt	220 x 317 x 435 [mm]

Registro de datos

La soldadora PolyControl Plus (USB) V2.0 proporciona el registro de datos de soldadura para unos 1000 ciclos y datos de rastreo de conformidad con la norma ISO-12176-4:

Embalaje

Tipo	Flightcase
Dimensiones	500 x 420 x 385 [mm]
Peso del embalaje	8 [kg]
Peso para el transporte	24 [kg]

Datos registrados

Datos de fusión	Tensión, corriente, consumo, duración del proceso (nominal y real) Hora, modo, resistencia, mensajes de error con 10 valores de tensión y corriente
Datos accesorio	Código de barras (ISO/TR 13950), Tipo, Dimensión, Fabricante
Datos del dispositivo	Nº de serie, Nº de inventario, Fecha del último servicio, Horas de trabajo, Configuración del sistema
Código de barras del operador	(PF o ISO 12176-3) identificación personal y acceso a entrada manual y configuración del sistema

Funciones de rastreo

Nº encargo (código del trabajo)	Max. 40 caracteres (alfanuméricos) por código de barras
Código operador	ISO-12176-3
Número Sold.	DVS 2207 / 2208
Código soldadura	ISO-TR 13950
Rastreo código accesorio	ISO-12176-4
Rastreo código tubo 1	ISO-12176-4
Rastreo código tubo 2	ISO-12176-4
Rastreo código 3 / Infotext	ISO-12176-4 / 40 caracteres

Ciclo de servicio conformidad con ISO 12176-2 a 30%, 60% y 100%, Duración test t = 60 minutos

Duración test 60 min	Potencia de salida a Uout = 36 V	Potencia de salida a Uout = 40 V	Corriente de salida Iout
30%	3960 W	4400 W	110 A
60%	3600 W	4000 W	100 A
100%	3240 W	3600 W	90 A

Polymatic Plus (USB + Bluetooth)

29143.0307.103

Rango de aplicación

Las soldadoras de electrofusión del tipo Polymatic Plus (USB) están exclusivamente destinadas a la soldadura de tubos termoplásticos (o sea de PE-HD, PE80, PE100 o PP) con accesorios de menos de 48V en su voltaje de entrada.

Estos dispositivos cumplen las especificaciones de las normativas DVS 2208-1 e ISO-12176-2, de las cuales derivan las normas aplicables a los equipos de electrofusión.



Rango de dimensiones

El rango de dimensiones de los accesorios para los cuales puede utilizarse una soldadora depende en primer lugar del consumo de energía de los accesorios. Dado que el consumo no es uniforme para todos los fabricantes, no es posible generalizar, y en caso de duda, es preciso examinar cada accesorio por separado. Para las soldadoras del tipo Polymatic Plus (USB), y suponiendo que todas las operaciones de soldadura se realizan en secuencia, es decir que la soldadora tiene tiempo para enfriarse mientras se prepara el accesorio siguiente, se podría emitir la siguiente declaración general:

Sin limitaciones para el uso con accesorios de 20 a 630mm. Al trabajar con dimensiones a partir de los 630mm se requieren periodos más prolongados de enfriamiento, porque de otro modo podría aparecer el mensaje de error "Device too hot" (Dispositivo recalentado). En tal caso será preciso dejar que el equipo se enfríe antes de volver a utilizarlo. Antes de procesar accesorios dentro de este rango de dimensiones es necesario comprobar que la demanda de corriente del accesorio no sobrepase constantemente la corriente de salida del dispositivo, y tener cuidado de no sobrepasar la corriente máxima de salida. Todo lo dicho se refiere al trabajo con una temperatura ambiente de 20°C.

Especificaciones técnicas

3_0206_103

Polymatic Plus (USB)

General

Tensión de salida	8 a 48 DC [V]
Registro de datos	Sí
Potencia (60% del tiempo ON) conformidad con ISO 12176-2	2600 W (72.5 A)
Rango de temperaturas	-10 a +50 [°C]
Protección	IP54
Clase de aplicación	1
Conformidad con	CE
Clase ISO 12176-2 - clasificación	P ₂ 4 U S ₁ V AK D X

Entrada de parámetros de soldadura

Código de barras con lector (escaneo opcional)	Sí
SmartFuse/(FUSAMATIC)	Sí
Entrada manual del código del accesorio	Sí
Entrada manual de parámetros de soldadura	Sí, U _{OUT} : 8 a 48 V, tWELD: 0 a 9999 s
Entrada manual de parámetros de soldadura	No, U _{OUT} : 48V (prefijado), tWELD: 0 a 9999 s

Entrada/Red eléctrica

Tensión	AC
Tensión nominal	230 [V]
Rango de tensión nominal (tolerancia)	185 a 300 [V]
Frecuencia nominal	50 [Hz]
Rango de frecuencia nominal (Tolerancia)	40 a 70 [Hz]
Factor de potencia cos ϕ	0.6 a 0.9 (control de desfase)
Corriente nominal	16 [A]
Consumo eléctrico	3600 [VA]
Longitud del cable	4.5 [m]
Tipo de enchufe	Euro plug

Especificaciones técnicas

3_0206_103

Polymatic Plus (USB)

Salida

Tensión	AC
Tensión de salida	8 a 48 [V]
Corriente de salida (max.)	110 [A]
Corriente de salida (t → ∞)	40 [A]
Corriente de salida (min.)	2 [A]
Ajuste de energía	Compensación de temperatura
Longitud del cable de soldadura	5 [m], otras longitudes a pedido
Montaje del cable de soldadura	Fijo
Terminales de soldadura	4 [mm]
Adaptadores opcionales para terminales	4 to 4.7 [mm]

Funciones de monitorización

Tensión de entrada	Corriente, Frecuencia
Tensión de salida	Corriente, Resistencia, Contacto, Cortocircuito
Otro	Sistema, Temperatura de trabajo, Servicio
Mensajes de error	Texto, Señal acústica

Caja

Material	Placa de acero con recubrimiento plástico
Pantalla	4 x 20 caracteres (alfanuméricos), iluminación de fondo
Peso del producto (sin cable de soldadura)	16 [kg]
Peso del producto (cable de soldadura incluido)	18 [kg]
Dimensiones Long x An x Alt	450 x 325 x 380 [mm]

Registro de datos

La soldadora Polymatic Plus (USB) proporciona el registro de datos de soldadura para 1000 ciclos.

Embalaje

Tipo	Flightcase
Dimensiones	500 x 420 x 385 [mm]
Peso del embalaje	8 [kg]
Peso para el transporte	24 [kg]

Datos registrados

Datos generales	Hora, fecha, número de informe, temperatura ambiente
Datos de fusión	Tensión, corriente, consumo, duración del proceso (nominal y real), Hora, modo, resistencia, mensajes de error con 10 valores de tensión y corriente
Datos accesorio	Código de barras (ISO/TR 13950), Tipo, Dimensión, Fabricante
Datos del dispositivo	Nº de serie, Nº de inventario, Fecha del último servicio, Horas de trabajo, Configuración del sistema
Código operador	(PF o ISO 12176-3) identificación personal y acceso a entrada manual y configuración del sistema

Funciones de rastreo

Código	Encargo y Nº (máximo 40 caracteres) ingreso por código de barras o manual
Código operador	ISO-1276-3
Número Sold.	DVS 2207 / 2208
Código soldadura	ISO-TR 13950
Rastreo código accesorio	ISO-12176-4
Rastreo código tubo 1	ISO-12176-4
Rastreo código tubo 2	ISO-12176-4
Rastreo código 3 / Infotext	ISO-12176-4 / 40 caracteres

Ciclo de servicio conformidad con ISO 12176-2 a 30%, 60% y 100%, Duración test t = 60 minutos

Duración test 60 min	Potencia de salida a U _{OUT} = 36 V	Potencia de salida a U _{OUT} = 40 V	Corriente de salida I _{OUT}
30%	3500 W	3900 W	97.3 A
60%	2600 W	2900 W	72.5 A
100%	2100 W	2350 W	58.4 A

Tiny Data MF (USB + Bluetooth)

29143.0308T108

Rango de aplicación

Las soldadoras de electrofusión del tipo Tiny MF (USB) están exclusivamente destinadas a la soldadura de tubos termoplásticos (o sea de PE-HD, PE80, PE100 o PP) con accesorios de menos de 48V en su voltaje de entrada.

Estos dispositivos cumplen las especificaciones de las normativas DVS 2208-1 e ISO-12176-2, de las cuales derivan las normas aplicables a los equipos de electrofusión.



Rango de dimensiones

El rango de dimensiones de los accesorios para los cuales puede utilizarse una soldadora depende en primer lugar del consumo de energía de los accesorios. Dado que el consumo no es uniforme para todos los fabricantes, no es posible generalizar, y en caso de duda, es preciso examinar cada accesorio por separado. Para las soldadoras del tipo Tiny MF (USB), y suponiendo que todas las operaciones de soldadura se realizan en secuencia, es decir que la soldadora tiene tiempo para enfriarse mientras se prepara el accesorio siguiente, se podría emitir la siguiente declaración general:

Sin limitaciones para el uso con accesorios de 20 a 355mm. Al trabajar con dimensiones a partir de los 400mm se requieren periodos más prolongados de enfriamiento, porque de otro modo podría aparecer el mensaje de error "Device too hot" (Dispositivo recalentado). En tal caso será preciso dejar que el equipo se enfríe antes de volver a utilizarlo. Antes de procesar accesorios dentro de este rango de dimensiones es necesario comprobar que la demanda de corriente del accesorio no sobrepase constantemente la corriente de salida del dispositivo, y tener cuidado de no sobrepasar la corriente máxima de salida. Todo lo dicho se refiere al trabajo con una temperatura ambiente de 20°C.

Especificaciones técnicas

3_0208T108

Tiny Data MF (USB)

General

Tensión de salida	8 a 48 DC
Registro de datos	Sí
Potencia (60% del tiempo ON) conformidad con ISO 12176-2	2050 W (55.9 A)
Rango de temperaturas	-10 a +50 [°C]
Protección	IP54
Clase de aplicación	1
Conformidad con	CE
Clase ISO 12176-2 - clasificación	P ₂ 3 U S ₁ V AK D X

Entrada de parámetros de soldadura

Código de barras con lector (escaneo opcional)	Sí
SmartFuse/(FUSAMATIC)	Sí
Entrada manual del código del accesorio	Sí
Entrada manual de parámetros de soldadura	Sí, U _{OUT} : 8 a 48 V, twELD: 0 a 9999 s
Entrada manual de parámetros de soldadura	No, U _{OUT} : 48V (prefijado), twELD: 0 a 9999 s

Entrada/Red eléctrica

Tensión	AC
Tensión nominal	230 [V]
Rango de tensión nominal (tolerancia)	185 a 300 [V]
Frecuencia nominal	50 [Hz]
Rango de frecuencia nominal (Tolerancia)	40 a 70 [Hz]
Factor de potencia cos ϕ	0.6 a 0.9 (control de desfase)
Corriente nominal	16 [A]
Consumo eléctrico	3200 [VA]
Longitud del cable	5 [m]
Tipo de enchufe	Euro plug

Especificaciones técnicas

3_0208T108

Tiny Data MF (USB)

Salida

Tensión	AC
Tensión de salida	8 a 48 [V]
Corriente de salida (max.)	110 [A]
Corriente de salida (t → ∞)	30 [A]
Corriente de salida (min.)	2 [A]
Ajuste de energía	Compensación de temperatura
Longitud del cable de soldadura	4 [m], otras longitudes a pedido
Montaje del cable de soldadura	Fijo
Terminales de soldadura	4.0 [mm] (opcional 4.7 [mm])

Funciones de monitorización

Tensión de entrada	Corriente, Frecuencia
Tensión de salida	Corriente, Resistencia, Contacto, Cortocircuito
Otro	Sistema, Temperatura de trabajo, Servicio
Mensajes de error	Texto, Señal acústica

Caja

Material	Placa de acero
Pantalla	4 x 20 caracteres (alfanuméricos), iluminación de fondo
Peso del producto (sin cable de soldadura)	14 [kg]
Peso del producto (cable de soldadura incluido)	16.5 [kg]
Dimensiones Long x An x Alt	325 x 275 x 290 [mm]

Registro de datos

La soldadora Tiny Data MF (USB) proporciona el registro de datos de soldadura para unos 1000 ciclos.

Embalaje

Tipo	Flightcase
Dimensiones	500 x 420 x 385 [mm]
Peso del embalaje	8 [kg]
Peso para el transporte	24 [kg]

Datos registrados

Datos generales	Hora, fecha, número de informe, temperatura ambiente
Datos de fusión	Tensión, corriente, consumo, duración del proceso (nominal y real), Hora, modo, resistencia, mensajes de error con 10 valores de tensión y corriente
Datos accesorio	Código de barras (ISO/TR 13950), Tipo, Dimensión, Fabricante
Datos del dispositivo	Nº de serie, Nº de inventario, Fecha del último servicio, Horas de trabajo, Configuración del sistema
Código operador	(PF o ISO 12176-3) identificación personal y acceso a la configuración del sistema

Funciones de rastreo

Código	Encargo y Nº (máximo 40 caracteres) ingreso por código de barras o manual
Código operador	ISO-1276-3
Número Sold.	DVS 2207 / 2208
Código soldadura	ISO-TR 13950
Rastreo código accesorio	ISO-12176-4
Rastreo código tubo 1	ISO-12176-4
Rastreo código tubo 2	ISO-12176-4
Rastreo código 3 / Infotext	ISO-12176-4 / 40 caracteres

Ciclo de servicio conformidad con ISO 12176-2 a 30%, 60% y 100%, Duración test t = 60 minutos

Duración test 60 min	Potencia de salida a U _{OUT} = 36 V	Potencia de salida a U _{OUT} = 40 V	Corriente de salida I _{OUT}
30%	2700 W	3000 W	74.1 A
60%	2050 W	2250 W	55.9 A
100%	1600 W	1800 W	44.7 A

Monomatic Data (USB + Bluetooth)

29143.0307.000

Soldadora automática SmartFuse

Rango de aplicación

Las soldadoras de electrofusión del tipo Monomatic Data (USB) están exclusivamente destinadas a la soldadura de tubos termoplásticos (o sea de PE-HD, PE80, PE100 o PP) con accesorios de menos de 48V en su voltaje de entrada.

Estos dispositivos cumplen las especificaciones de las normativas DVS 2208-1 e ISO-12176-2, de las cuales derivan las normas aplicables a los equipos de electrofusión.



Rango de dimensiones

El rango de dimensiones de los accesorios para los cuales puede utilizarse una soldadora depende en primer lugar del consumo de energía de los accesorios. Dado que el consumo no es uniforme para todos los fabricantes, no es posible generalizar, y en caso de duda, es preciso examinar cada accesorio por separado. Para las soldadoras del tipo Monomatic Data (USB), y suponiendo que todas las operaciones de soldadura se realizan en secuencia, es decir que la soldadora tiene tiempo para enfriarse mientras se prepara el accesorio siguiente, se podría emitir la siguiente declaración general:

Sin limitaciones para el uso con accesorios de 20 a 355mm. Al trabajar con dimensiones a partir de los 400mm se requieren periodos más prolongados de enfriamiento, porque de otro modo podría aparecer el mensaje de error "Device too hot" (Dispositivo recalentado). En tal caso será preciso dejar que el equipo se enfríe antes de volver a utilizarlo. Antes de procesar accesorios dentro de este rango de dimensiones es necesario comprobar que la demanda de corriente del accesorio no sobrepase constantemente la corriente de salida del dispositivo, y tener cuidado de no sobrepasar la corriente máxima de salida. Todo lo dicho se refiere al trabajo con una temperatura ambiente de 20°C.

Especificaciones técnicas

3_0206_000

Monomatic Data (USB)

General

Tensión de salida	40 AC [V]
Registro de datos	Sí
Potencia (60% del tiempo ON) conformidad con ISO 12176-2	2050 W (55.9 A)
Rango de temperaturas	-10 a +50 [°C]
Protección	IP54
Clase de aplicación	1
Conformidad con	CE
Clase ISO 12176-2 - clasificación	P ₂ 3 U S ₁ F A D M

Entrada de parámetros de soldadura

Código de barras con lector (escaneo opcional)	No
SmartFuse/(FUSAMATIC)	Sí
Entrada manual del código del accesorio	No
Entrada manual de parámetros de soldadura	No, U _{OUT} : 8 a 48 V, t _{WELD} : 0 a 9999 s
Entrada manual de parámetros de soldadura	No, U _{OUT} : 48V (prefijado), t _{WELD} : 0 a 9999 s

Entrada/Red eléctrica

Tensión	AC
Tensión nominal	230 [V]
Rango de tensión nominal (tolerancia)	185 a 300 [V]
Frecuencia nominal	50 [Hz]
Rango de frecuencia nominal (Tolerancia)	40 a 70 [Hz]
Factor de potencia cos ϕ	0.6 a 0.9 (control de desfase)
Corriente nominal	16 [A]
Consumo eléctrico	3600 [VA]
Longitud del cable	4.5 [m]
Tipo de enchufe	Euro plug

Especificaciones técnicas

3_0206_000

Monomatic Data (USB)

Salida

Tensión	AC
Tensión de salida	40 [V]
Corriente de salida (max.)	110 [A]
Corriente de salida (t → ∞)	30 [A]
Corriente de salida (min.)	2 [A]
Ajuste de energía	Ninguno
Longitud del cable de soldadura	5 [m], otras longitudes a pedido
Montaje del cable de soldadura	Fijo
Terminales de soldadura	4.0 [mm] (opcional 4.7 [mm])

Funciones de monitorización

Tensión de entrada	Corriente, Frecuencia
Tensión de salida	Corriente, Resistencia, Contacto, Cortocircuito
Otro	Otro sistema, Temperatura de trabajo, Servicio
Mensajes de error	Texto, Señal acústica

Caja

Material	Placa de acero con recubrimiento plástico
Pantalla	4 x 20 caracteres (alfanuméricos), iluminación de fondo
Peso del producto (sin cable de soldadura)	16 [kg]
Peso del producto (cable de soldadura incluido)	18 [kg]
Dimensiones Long x An x Alt	450 x 325 x 380 [mm]

Registro de datos

La soldadora Monomatic Data (USB) proporciona el registro de datos de soldadura para 250 ciclos.

Embalaje

Tipo	Flightcase
Dimensiones	500 x 420 x 385 [mm]
Peso del embalaje	8 [kg]
Peso para el transporte	24 [kg]

Datos registrados

Datos generales	Hora, fecha, número de informe, temperatura ambiente
Datos de fusión	Tensión, corriente, consumo, duración del proceso (nominal y real), Hora, modo, resistencia, mensajes de error con 10 valores de tensión y corriente
Datos del dispositivo	Nº de serie, Nº de inventario, Fecha del último servicio Horas de trabajo, Configuración del sistema

Ciclo de servicio conformidad con ISO 12176-2 a 30%, 60% y 100%, duración test t = 60 minutos

Duración test 60 min	Potencia de salida a Uout = 36 V	Potencia de salida a Uout = 40 V	Corriente de salida Iout
30%	2700 W	3000 W	74.1 A
60%	2050 W	2250 W	55.9 A
100%	1600 W	1800 W	44.7 A

Extension Key for Tapping Valve

Llave de Extensión para Toma de Servicio Con Válvula

49546010 | 0.8 - 1.1mm

49546020 | 1.0 - 1.4mm

49546030 | 1.2 - 1.8mm



Key for Tapping Saddle

Llave para Toma de Servicio

29202000 | 18cm



Hand Scrapers

Raspatubos Manual

29145.3002.001 | 1.1/2"

29145.3002.003 | 2.1/2"



Rotational Scraper Tools

Raspatubos Giratorios

29144.4200.001 | 20-63mm

29144.4200.031 | 20-125mm

29144.4200.032 | 63-225mm

29144.4200.033 | 90-315mm



29170160 | 50-160mm

29170315 | 75-315mm

29170710 | 355-710mm



29144.4200.009 | 250-800mm



Plasson Scraper Tool for Pipe Ends

Raspatubos Giratorio Plasson

- 29144.4200.015 | 63-200mm
- 29144.4200.027 | 90-315mm
- 29144.4200.016 | 180-400mm
- 2912450800 | 450-800mm



Pipe Cutter

Cortadores de Tubería

- 29145.3000.005 | 42mm



- 29145.3000.007 | 63mm, One-Hand Operation



- 29145.3000.001 | 63mm



Rotational Pipe Cutter (S-Type)

Cortador de Tubería Giratorio (Tipo S)

- 29145.3001.004 | 20-75mm
- 29145.3001.001 | 50-140mm
- 29145.3001.002 | 90-160mm



Rotational Pipe Cutters

Cortador de Tubería Giratorio

- 29144.4400.006 | 32-125mm
- 29144.4400.004 | 63-200mm
- 29144.4400.005 | 90-315mm



Pipe Clamping Tools

Herramientas de Sujeción de Tubos

29144.4300.006 | 20-63mm



29144.4300.001 | 32-110mm

29144.4300.002 | 110-225mm



29144.4300.021 | 250-630mm



29363180 | 63-180mm

29363110 | 63-110mm



Squeeze - Off Tools

Prensatubos

29144.4100.010 | 63mm SDR11,, SDR17

29144.4100.003 | 75-200mm



Pipe Clamping Tools

Herramientas de Sujeción de Tubos

- 29145.3006.063 | 63mm
- 29145.3006.075 | 75mm
- 29145.3006.090 | 90mm
- 29145.3006.110 | 110mm
- 29145.3006.125 | 125mm
- 29145.3006.160 | 160mm
- 29145.3006.180 | 180mm
- 29145.3006.200 | 200mm
- 29145.3006.225 | 225mm
- 29600250 | 250mm



Detergents

Detergentes

- 29145.2000.001 | Tangit Detergent, 1 Liter



- 29145.2000.002 | 100 Cleaning Pads with Tangit



Markers

Marcadores

- 29145.3100.019 | Plasson Marking Pen, Silver, 10 pcs
- 29600003 | Plasson Marking Pen, Silver, 10 pcs



Rounding Tool

Redondeador hidráulico

29144.4702.000 | Rounding Tool 450-800 Hydraulic
Redondeador hidráulico 450-800



Tools for Wastewater Saddles (See Pages 138, 139)

Herramientas para enlaces para aguas residuales (ver páginas 138 y 139)

29144.4700.001 | Drilling And Clamping Tools (set) for Wastewater Branch Saddle 160mm
Juego de herramientas de perforación y sujeción para collarines de derivación para aguas residuales 160mm



29144.4703.001 | Cutting and Clamping Tools for 45° Wastewater Saddle 110mm
Herramientas de corte y sujeción para collarines de 45° para aguas residuales 110mm



Rotational Scraper Tools

Rascador giratorio para tuberías de PEAD

29144.4200.009 | 250-800mm
 29144.4200.012 | 800-1200mm



Electrical Saddle Scraper

Rascador eléctrico para tuberías de PEAD

29144.4200.024 | 230V (Electrical Scraper)



Core Drill Kit for Plasson-Saddle Outlet

29144.4702.002 | 2"female, 3"ips/ 4"ips/ 4"dips with sds-max-adapter+suitcase+ pilot drill, sds plus



Drilling Machine

29144.4702.999 | Drilling machine (Metabo BE75-X3/230V) with modified 225Nm gear including hexagon bit and adapter for core cutter for use up to 250mm



Pressure Test Pump

29144.4701.005 | Pressure test pump with adapter for plasson large bore saddles



Hot Tapping Tool

29144.4705.001 | Hot tapping tool ISO Flange DN150 with 230V motor



Saddle Pressing Tool

29142.4701.066 | Pressing tool 225mm/SDR17 for Waste Water Saddle



Saddle Clamping Tool

29142.4701.226 | Clamping plate 225mm/SDR17 splitable, for Waste Water Saddle, PLASSON



Saddle Clamping Tool

29144.4701.315 | Saddle clamp 250-800mm splitable; Outlet 315mm; PLASSON; incl. pressing tool in suitcase



Saddle Pressing and Clamping Tools

Herramientas necesarias para la instalación de Collarines de derivación y transición de gran diámetro

29144.4701.003 | Split-able saddle clamp – complete kit including re-rounder, straps, ratchets, test tube cutter, clamping plates for outlets:
 2" threaded transition/90/flange DN80, 110, 125/ flange DN100, 160/flange DN150
 Juego completo de barras sujetadoras con bisagras incluye redondeador, 2 cinchas, 2 cremalleras de amarre, cortador de tubo de prueba de presión, plancha de barras sujetadores para collarines de salidas:
 2" transición roscada, 90mm, 110mm, 125mm, 160mm y salidas bridadas respectivamente



29144.4701.004 | Large bore splitable saddle clamp 10 ips a 32 ips/ complete kit include outlets 3"ips, 4"ips y 4"dips

29144.4701.250* | Split-able clamping plate for outlet 250/flange DN 250, including- re-rounding shell
 Juego completo de barras sujetadoras con bisagras para salidas de 250mm y bridado. Incluye redondeador metálico para la salida 250mm



29144.4701.400* | Split-able clamping plate for outlet 400/flange DN 400, including adaptor for center strap
 Juego completo de barras sujetadoras con bisagras para salidas de 400mm y bridado. Incluye cincha redondeadora y centralizadora para la salida 400mm y bridado



29144.4701.009 | Tensioning tools set for large branch saddles, outlets 180 to 400, including 3 straps, 3 ratchets, torque wrench
 Juego completo de cinchas de amarre, cremalleras y tensión para collarines de derivación con salidas desde 180mm a 400mm, incluye: 3 cinchas, 3 cremalleras de amarre y llave de torque



* Must be used in combination with tensioning tools set 29144.4701.009

Core cutters- for each outlet size

Brocas campana para cada diámetro

29144.4702.003 | Core cutters set including: SDS max core, SDS plus core, 13mm core, center pilot drill, cutters for outlets:
2" threaded transition, 90/flange DN80, 110, 125/ flange DN100, 160/flange DN150
Juego de brocas campana de corte. Incluye: SDS max core, SDS plus core, 13mm core, center pilot drill, Brocas para corte y perforación de salidas: broca 2" transición roscada, brocas campana para 90mm, 110mm, 125mm, 160mm y bridadas respectivamente



29144.4702.199 | Core cutter for outlet 250/ flange DN 250
Broca campana para salida 250/ bridado DN 250

29142.4704.196 | Core cutter for PLASSON-Saddle outlet 225mm/SDR17;
borehole: 196mm c/w SDS-MAX adapter

29142.4702.251 | Core cutter for PLASSON-Saddle outlet 315mm/SDR11;
borehole: 251mm c/w SDS-MAX adapter, center drill and transport box



29144.4702.319 | Core cutter for outlet 400/ flange DN 400
Broca campana para salida 400/ bridado DN 400



Minimum required Generator Output power

Potencia mínima requerida de un generador de energía eléctrica, Potencia de salida

Voltage- 240 V, frequency- 50Hz, 1 phase
Synchronized, recommended - Mechanically regulated.

Fitting size	Output power Mechanically controlled generator	Output power Electronically controlled generator
20-75mm	2.0 KVA	2.0 KVA
90-160mm	3.2 KVA	3.2 KVA
180-500mm	4.5 KVA	5.0 KVA
500mm and up	6.5 KVA	7.5 KVA

When operating at high altitudes, rated generator power drops 10% for each 1000 meters. Use larger generator accordingly.

Sea level	1000m	2000m	3000m
3.2 KVA	3.5 KVA	4.0 KVA	4.2 KVA
4.5 KVA	5.0 KVA	5.5 KVA	6.5 KVA
6.5 KVA	7.5 KVA	8.0 KVA	8.5 KVA

Voltaje- 240 V, frecuencia- 50Hz, 1 fase
Generador sincronizado, recomendable de regulación mecánica.

Diámetro de accesorios	Potencia de salida de regulación mecánica	Potencia de salida de regulación electrónica
20-75mm	2.0 KVA	2.0 KVA
90-160mm	3.2 KVA	3.2 KVA
180-500mm	4.5 KVA	5.0 KVA
500mm and up	6.5 KVA	7.5 KVA

Cuando trabaje en zonas altas o elevadas considere una caída de potencia del generador del orden del 10% cada 1,000 metros de altura. Calcular la potencia necesaria acorde a la altura en la que se llevara a cabo la obra.

Potencia: Reducción de potencia aproximada = 10% cada 1,000 metros sobre el nivel del mar. El operador debe considerar la potencia necesaria del generador de acuerdo a la altitud sobre el nivel del mar en la que va a trabajar.

Características de un generador a combustible:

En Plasson para el uso con máquinas de electrofusión consideramos optimo min. 5.5kW para uso a nivel del mar.

1,000 mts. sobre el nivel del mar : min 6.1kW

2,000 mts. sobre el nivel del mar : min 6.9kW

2,800 mts. sobre el nivel del mar : min. 7.6kW

3,000 mts. sobre el nivel del mar : min. 7.9kW

Power (on altitude) = 5.5kW / (1 - (altitude / 10000m)).

Extension power cable size

Cable alargador de alimentación

Cable length	Minimum cross-section
Up to 20 meters	1.5mm ²
20-50 meters	2.5mm ²
50-100 meters	4.0mm ²

Largo del cable	Grosor mínimo
Hasta 20 metros	1.5mm ²
20-50 metros	2.5mm ²
50-100 metros	4.0mm ²

